



**2016**

**Grand Cherokee**

---

OWNER'S MANUAL

SUPPLEMENT

## **VEHICLES SOLD IN CANADA**

With respect to any Vehicles Sold in Canada, the name FCA US LLC shall be deemed to be deleted and the name FCA Canada Inc. used in substitution therefore.

## **DRIVING AND ALCOHOL**

Drunken driving is one of the most frequent causes of accidents.

Your driving ability can be seriously impaired with blood alcohol levels far below the legal minimum. If you are drinking, don't drive. Ride with a designated non-drinking driver, call a cab, a friend, or use public transportation.

### **WARNING!**

**Driving after drinking can lead to an accident. Your perceptions are less sharp, your reflexes are slower, and your judgment is impaired when you have been drinking. Never drink and then drive.**

This manual illustrates and describes the operation of features and equipment that are either standard or optional on this vehicle. This manual may also include a description of features and equipment that are no longer available or were not ordered on this vehicle. Please disregard any features and equipment described in this manual that are not on this vehicle.

FCA US LLC reserves the right to make changes in design and specifications, and/or make additions to or improvements to its products without imposing any obligation upon itself to install them on products previously manufactured.



# TABLE OF CONTENTS

SECTION		PAGE
1	INTRODUCTION .....	3
2	THINGS TO KNOW BEFORE STARTING YOUR VEHICLE .....	7
3	UNDERSTANDING YOUR INSTRUMENT PANEL .....	11
4	STARTING AND OPERATING .....	29
5	MAINTAINING YOUR VEHICLE .....	69
6	MAINTENANCE SCHEDULE .....	97
7	INDEX .....	105

1

2

3

4

5

6

7



---

# INTRODUCTION

## CONTENTS

---

■ A MESSAGE FROM FCA US LLC . . . . .	4
---------------------------------------	---

### A MESSAGE FROM FCA US LLC

FCA US LLC welcomes you as a turbocharged diesel-powered vehicle owner. Your diesel vehicle will sound, feel, drive and operate differently from a gasoline-powered vehicle. It is important that you read and understand this manual.

Almost 100% of the heavy trucks in the United States and Canada are diesel-powered because of the fuel economy, rugged durability, and high torque which permits pulling heavy loads.

You may find that some of the starting, operating, and maintenance procedures are different. However, they are simple to follow and careful adherence to them will ensure that you take full advantage of the features of this engine.

### NOTE:

- Some aftermarket products may cause severe engine/transmission and/or exhaust system damage. Your vehicle's powertrain control systems can detect and store information about vehicle modifications that increase horsepower and torque output such as whether or not performance-enhancing powertrain components, commonly referred to as downloaders, power boxes, or performance chips have been used.
- Any chassis/suspension or tire size modifications to the vehicle will effect the performance of the Adaptive Cruise Control and Forward Collision Warning System.

This information cannot be erased and will stay in the system's memory even if the modification is removed. This information can be retrieved by FCA US LLC, and service and repair facilities, when servicing your vehicle.

This information may be used to determine if repair will be covered by New Vehicle Limited Warranty.

There is a probability that the use of a “performance chip” will prohibit the engine from starting. In this instance, the vehicle will need to be serviced by a authorized dealer in order to return the vehicle to it’s factory settings.

When it comes to service, remember that your authorized dealer knows your Jeep® vehicle best, has factory-trained technicians and genuine MOPAR® parts, and cares about your satisfaction.





# THINGS TO KNOW BEFORE STARTING YOUR VEHICLE

## CONTENTS

---

■ REMOTE STARTING SYSTEM . . . . .	.8	■ ENGINE BREAK-IN RECOMMENDATIONS . . . . .	.9
□ How To Use Remote Start . . . . .	.8		

### REMOTE STARTING SYSTEM



This system uses the RKE Key Fob to start the engine conveniently from outside the vehicle while still maintaining security. The system has a range of approximately 300 ft (91 m).

#### NOTE:

- The vehicle must be equipped with an automatic transmission to be equipped with Remote Start.
- Obstructions between the vehicle and the RKE Key Fob may reduce this range.
- The Remote Start system will wait for the “Wait To Start” amber telltale to extinguish before cranking the engine. This allows time for the engine pre-heat cycle to pre-heat the cylinder air, and is normal in cold

weather. Refer to “Electronic Vehicle Information Display (EVIC)” in “Understanding Your Instrument Panel” for further information on the “Wait To Start” amber telltale and the pre-heat cycle.

#### How To Use Remote Start

All of the following conditions must be met before the engine will remote start:

- Gear selector in PARK
- Doors closed
- Hood closed
- HAZARD switch off
- BRAKE switch inactive (brake pedal not pressed)
- Battery at an acceptable charge level
- RKE PANIC button not pressed

- Fuel meets minimum requirement
- System not disabled from previous remote start event
- Vehicle security alarm not active
- Water In Fuel Indicator Light is not illuminated
- “Wait To Start” telltale is not illuminated

### **WARNING!**

- **Do not start or run an engine in a closed garage or confined area. Exhaust gas contains Carbon Monoxide (CO) which is odorless and colorless. Carbon Monoxide is poisonous and can cause serious injury or death when inhaled.**
- **Keep Remote Keyless Entry (RKE) transmitters away from children. Operation of the Remote Start System, windows, door locks or other controls could cause serious injury or death.**

### **ENGINE BREAK-IN RECOMMENDATIONS**

The diesel engine does not require a break-in period due to its construction. Normal operation is allowed, providing the following recommendations are followed:

- Warm up the engine before placing it under load.
- Do not operate the engine at idle for prolonged periods.
- Use the appropriate transmission gear to prevent engine lugging.
- Observe vehicle oil pressure and temperature indicators.
- Check the coolant and oil levels frequently.
- Vary throttle position at highway speeds when carrying or towing significant weight.

## 10 THINGS TO KNOW BEFORE STARTING YOUR VEHICLE

---

**NOTE:** Light duty operation such as light trailer towing or no load operation will extend the time before the engine is at full efficiency. Reduced fuel economy and power may be seen at this time.

The engine oil installed in the engine at the factory is a high-quality energy conserving type lubricant. Oil changes should be consistent with anticipated climate conditions under which vehicle operations will occur. The recommended viscosity and quality grades are shown under “Fluids, Lubricants and Genuine Parts”, under “Maintaining Your Vehicle” in this manual. **NON-DETERGENT OR STRAIGHT MINERAL OILS MUST NEVER BE USED.**

# UNDERSTANDING YOUR INSTRUMENT PANEL

## CONTENTS

---

■ INSTRUMENT CLUSTER . . . . .	12	□ Fuel Filter Life Reset . . . . .	22
■ WARNING AND INDICATOR LIGHTS . . . . .	14	□ Diesel Particulate Filter (DPF) Messages . . . . .	23
□ Yellow Telltale Indicator Lights . . . . .	15	□ Diesel Exhaust Fluid (DEF) Warning Messages . . . . .	25
■ DRIVER INFORMATION DISPLAY (DID) . . . . .	18	□ Diesel Exhaust Fluid (DEF) Fault Warning Messages . . . . .	26
□ DID Displays . . . . .	20		
□ Engine Oil Life Reset . . . . .	21		

## INSTRUMENT CLUSTER

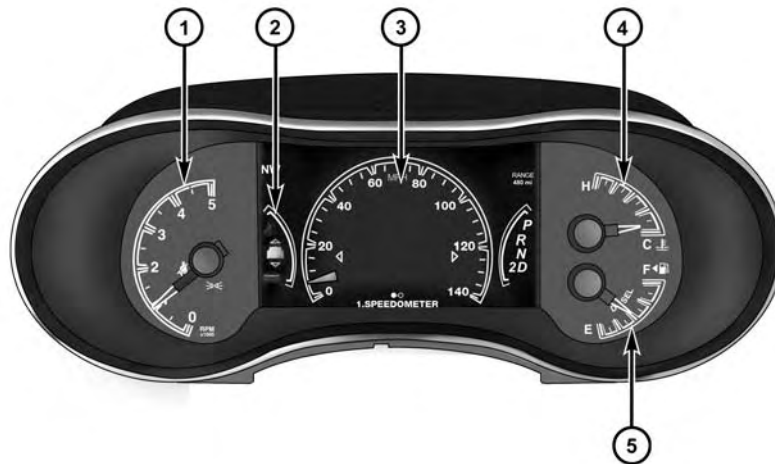

Premium DID Instrument Cluster

0403086276US

1. Tachometer
  - Indicates the engine speed in revolutions per minute (RPM x 1000).
2. Driver Information Display (DID)
  - The Driver Information Display (DID) features a driver-interactive display. Refer to “Driver Information Display (DID)” in “Understanding Your Instrument Panel” for further information.
3. Speedometer
  - Indicates vehicle speed
4. Temperature Gauge
  - The temperature gauge shows engine coolant temperature. Any reading within the normal range indicates that the engine cooling system is operating satisfactorily.

- The gauge pointer will likely indicate a higher temperature when driving in hot weather or up mountain grades. It should not be allowed to exceed the upper limits of the normal operating range.

**CAUTION!**

**Driving with a hot engine cooling system could damage your vehicle. If the temperature gauge reads “H” pull over and stop the vehicle. Idle the vehicle with the air conditioner turned off until the pointer drops back into the normal range. If the pointer remains on the “H”, turn the engine off immediately and call an authorized dealer for service.**

**WARNING!**

A hot engine cooling system is dangerous. You or others could be badly burned by steam or boiling coolant. You may want to call an authorized dealer for service if your vehicle overheats. If you decide to look under the hood yourself, see “Maintaining Your Vehicle”. Follow the warnings under the Cooling System Pressure Cap paragraph.

## 5. Fuel Gauge

- The pointer shows the level of fuel in the fuel tank when the ignition switch is in the ON/RUN position
- The fuel pump symbol points  to the side of the vehicle where the fuel door is located.

**WARNING AND INDICATOR LIGHTS**

**IMPORTANT:** The warning light switches on in the instrument panel together with a dedicated message and/or acoustic signal when applicable. These indications are indicative and precautionary and as such must not be considered as exhaustive and/or alternative to the information contained in the Owner Manual, which you are advised to read carefully in all cases. Always refer to the information in this chapter in the event of a failure indication.



## Yellow Telltale Indicator Lights

### Water in Fuel Indicator Light — If Equipped

Yellow Telltale Light	What It Means
	<p><b>Water in Fuel Indicator Light</b></p> <p>The “Water In Fuel Indicator Light” will illuminate when there is water detected in the fuel filters. If this light remains on, DO NOT start the vehicle before you drain the water from the fuel filters to prevent engine damage.</p>

## Wait To Start Light — If Equipped

Yellow Telltale Light	What It Means
	<p><b>Wait To Start Light</b></p> <p>The “Wait To Start” telltale will illuminate for approximately two seconds when the ignition is turned to the RUN position. It’s duration may be longer based on colder operating conditions. Vehicle will not initiate start until telltale is no longer displayed. Refer to “Starting Procedures” in “Starting and Operating” for further information.</p> <p><b>NOTE:</b> The “Wait To Start” telltale may not illuminate if the intake manifold temperature is warm enough.</p>

### Low Diesel Exhaust Fluid (DEF) Indicator Light — If Equipped

Yellow Telltale Light	What It Means
	<p><b>Low Diesel Exhaust Fluid (DEF) Indicator Light</b> The Low Diesel Exhaust Fluid (DEF) Indicator will illuminate if the vehicle is low on Diesel Exhaust Fluid (DEF). Refer to “Starting And Operating” for further information.</p>

### Loose Fuel Filler Cap Indicator Light — If Equipped

Yellow Telltale Light	What It Means
	<p><b>Loose Fuel Filler Cap Indicator Light — If Equipped</b> This light will illuminate when fuel filler cap is loose. Properly close the filler cap to disengage the light. If the light does not turn off, please see your authorized dealer.</p>

## DRIVER INFORMATION DISPLAY (DID)

The Driver Information Display (DID) features a driver-interactive display that is located in the instrument cluster.

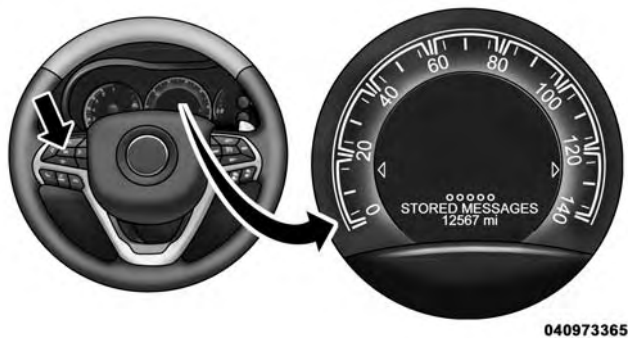

Driver Information Display (DID) Location

The DID Menu items consists of the following:

- Main Gauge
- Vehicle Info
- Terrain — If Equipped
- Driver Assist
- Fuel Economy
- Trip
- Stop/Start — If Equipped
- Audio
- Stored Messages
- Screen Setup
- Speed Warning — If Equipped

The system allows the driver to select information by pushing the following buttons mounted on the steering wheel:



DID Buttons

- ***UP Arrow Button***



Push and release the **UP** arrow button to scroll upward through the main menu and submenus (Main Gauge, MPH/km/h, Vehicle Info, Terrain, Driver Assist, Fuel Economy, Trip A, Trip B, Stop/Start, Audio, Stored Messages, Screen Set Up).

- ***DOWN Arrow Button***



Push and release the **DOWN** arrow button to scroll downward through the main menu and submenus (Main Gauge, MPH/km/h, Vehicle Info, Terrain, Driver Assist, Fuel Economy, Trip A, Trip B, Stop/Start, Audio, Stored Messages, Screen Set Up).

- *RIGHT Arrow Button*



Push and release the **RIGHT** arrow button to access the information screens or sub-menu screens of a main menu item.

- *BACK/LEFT Arrow Button*



Push and release the **LEFT** arrow button to access the information screens or sub-menu screens of a main menu item.

- *OK Button*

Push the **OK** button to access/select the information screens or sub-menu screens of a main menu item. Push and hold the **OK** button for two seconds to reset displayed/selected features that can be reset.

## **DID Displays**

When the appropriate conditions exist, the DID displays the following messages:

- Exhaust Filter Nearing Full Safely Drive at Highway Speeds to Clear
- Exhaust Filter Full – Power Reduced See Dealer
- Exhaust System Service Required – See Dealer
- Exhaust System – Filter XX% Full Service Required See Dealer
- Exhaust System Regeneration in Process Continue Driving
- Exhaust System – Regeneration Completed

- Engine Will Not Restart in XXXX mi DEF Low Refill Soon
- Engine Will Not Restart in XXXX mi Refill DEF
- Engine Will Not Start Refill DEF
- Service DEF System See Dealer
- Incorrect DEF Detected See Dealer
- Engine Will Not Restart in XXX mi Service DEF See Dealer
- Engine Will Not Restart Service DEF System See Dealer
- Engine Will Not Start Service DEF System See Dealer

## Engine Oil Life Reset

### Oil Change Required

Your vehicle is equipped with an engine oil change indicator system. The “Oil Change Required” message

will display in the DID for five seconds after a single chime has sounded, to indicate the next scheduled oil change interval. The engine oil change indicator system is duty cycle based, which means the engine oil change interval may fluctuate, dependent upon your personal driving style.

Unless reset, this message will continue to display each time you cycle the ignition to the ON/RUN position. To turn off the message temporarily, push and release the **OK** button. To reset the oil change indicator system (after performing the scheduled maintenance), refer to the following procedure.

### Oil Change Reset Procedure

1. Without pushing the brake pedal, push and release the ENGINE START/STOP button and place the ignition to the ON/RUN position (do not start the engine).
2. Fully push the accelerator pedal, slowly, three times within 10 seconds.

3. Without pushing the brake pedal, push and release the ENGINE START/STOP button once to return the ignition to the OFF/LOCK position.

**NOTE:** If the indicator message illuminates when you start the vehicle, the oil change indicator system did not reset. If necessary, repeat this procedure.

### Secondary Method For Oil Change Reset

1. Without depressing the brake pedal, push and release the ENGINE START/STOP button and place the ignition to the ON/RUN position (do not start the engine).
2. Navigate to "Oil Life" submenu in "Vehicle Info" on DID.
3. Push and Hold the **OK** button until the gauge resets to 100%.



### Fuel Filter Life Reset

The cluster will display the "Fuel System Service Required – See Dealer" or "Service Fuel Filter" message when the fuel filter maintenance life is less than 5%. To verify if this is a fuel filter change event, go to the "Fuel Filter Life" screen in the "Vehicle Info" menu. When this message appears, dealers should replace the fuel filters.

**NOTE:** Use the steering wheel DID controls for the following procedure(s)

1. Without pushing the brake pedal, cycle the ignition to the ON/RUN position (do not start the engine.)
2. Push and release the **DOWN**  arrow button to scroll downward through the main menu to "Vehicle Info."



3. Push and release the **RIGHT**  arrow button to access the "Fuel Filter Life" screen.
4. Push and hold the **OK** button for one second to access the "Fuel Filter Life Reset" screen.
5. Push and release the **DOWN**  arrow button to select "Yes," then push and release the **OK** button to select reset of the Fuel Filter Life.
6. Push and release the **UP**  arrow button to exit the DID screen.

**NOTE:** If the indicator message illuminates when you start the vehicle, the fuel filter indicator system did not reset. If necessary, repeat this procedure.

### **Diesel Particulate Filter (DPF) Messages**

This engine meets all required diesel engine emissions standards. To achieve these emissions standards, your vehicle is equipped with a state-of-the-art engine and

exhaust system. These systems are seamlessly integrated into your vehicle and managed by the Powertrain Control Module (PCM). The PCM manages engine combustion to allow the exhaust system's catalyst to trap and burn Particulate Matter (PM) pollutants, with no input or interaction on your part.

#### **WARNING!**

**A hot exhaust system can start a fire if you park over materials that can burn. Such materials might be grass or leaves coming into contact with your exhaust system. Do not park or operate your vehicle in areas where your exhaust system can contact anything that can burn.**

Your vehicle has the ability to alert you to additional maintenance required on your vehicle or engine. Refer to the following messages that may be displayed on your Driver Information Display (DID):

- **Exhaust Filter Nearing Full Safely Drive at Highway Speeds to Clear** — This message will be displayed on the Driver Information Display (DID) if the exhaust particulate filter reaches 80% of its maximum storage capacity. Under conditions of exclusive short duration and low speed driving cycles, your diesel engine and exhaust after-treatment system may never reach the conditions required to cleanse the filter to remove the trapped PM. If this occurs, the “Exhaust Filter XX% Full Safely Drive at Highway Speeds to Remedy” message will be displayed in the DID. If this message is displayed, you will hear one chime to assist in alerting you of this condition. By simply driving your vehicle at highway speeds for up to 20 minutes, you can remedy the condition in the particulate filter system and allow your diesel engine and exhaust after-treatment system to cleanse the filter to remove the trapped PM and restore the system to normal operating condition.
- **Exhaust System Regeneration in Process Continue Driving** — This message indicates that the Diesel Particulate Filter (DPF) is self-cleaning. Maintain your current driving condition until regeneration is completed.
- **Exhaust System — Regeneration Completed** — This message indicates that the Diesel Particulate Filter (DPF) self-cleaning is completed. If this message is displayed, you will hear one chime to assist in alerting you of this condition.
- **Exhaust System Service Required - See Dealer** — This messages indicates regeneration has been disabled due to a system malfunction. At this point the engine Powertrain Control Module (PCM) will register a fault code, the instrument panel will display a MIL light.

**CAUTION!**

See your authorized dealer, as damage to the exhaust system could occur soon with continued operation.

- **Exhaust Filter Full — Power Reduced See Dealer —**  
This message indicates the PCM has derated the engine to limit the likelihood of permanent damage to the after-treatment system. If this condition is not corrected and a dealer service is not performed, extensive exhaust after-treatment damage can occur. To correct this condition it will be necessary to have your vehicle serviced by your local authorized dealer.

**NOTE:** Failing to follow the oil change indicator, changing your oil and resetting the oil change indicator by 0 miles remaining will prevent the diesel exhaust filter from performing its cleaning routine. This will shortly result in a Malfunction Indicator Light (MIL) and reduced engine

power. Only an authorized dealer will be able to correct this condition.

**CAUTION!**

See your authorized dealer, as damage to the exhaust system could occur soon with continued operation.

3

**Diesel Exhaust Fluid (DEF) Warning Messages**

Your vehicle will begin displaying warning messages when the DEF level reaches a driving range of approximately 500 miles. If the following warning message sequence is ignored, your vehicle may not restart unless DEF is added within the displayed mileage shown in the DID message.

- **Engine Will Not Restart in XXXX mi DEF Low Refill Soon —** This message will display when DEF driving range is less than 500 miles, DEF fluid top off is required

with in the displayed mileage. The message will be displayed in the DID during vehicle start up with the current allowed mileage and accompanied by a single chime. The remaining mileage can be pulled up anytime by way of the “Messages” list within the DID

- **Engine Will Not Restart in XXXX mi Refill DEF** — This message will display when DEF driving range is less than 311 miles. It is also displayed at 249 miles, 186 miles, and 124 miles. Continuous Display starts at 124 miles. DEF fluid top off is required with in the displayed mileage. The message will be displayed in the DID during vehicle start up with an updated distance mileage, and it will be accompanied by a single chime. Starting at 100 miles, remaining range will be continuously displayed while operating the vehicle. Chimes will also accompany the 75, 50 and 25 mile remaining distances. The DEF Low telltale will be on continuously until DEF fluid is topped off.

- **Engine Will Not Restart Refill DEF** — This message will display when the DEF driving range is less than 1 mile, DEF fluid top off is required or the engine will not restart. The message will be displayed in the DID during vehicle start up, and it will be accompanied by a single chime. The DEF Low telltale will be illuminated continuously until DEF fluid tank is filled with a minimum of two gallons of DEF.

### **Diesel Exhaust Fluid (DEF) Fault Warning Messages**

There are different messages which are displayed if the vehicle detects that the DEF system has been filled with a fluid other than DEF, has experienced component failures, or when tampering has been detected.

When the DEF system needs to be serviced the following warnings will display:

- **Service DEF System See Dealer** — This message will display when the fault is initially detected and each

time the vehicle is started. The message will be accompanied by a single chime and the Malfunction Indicator Light. We recommend you drive to your nearest authorized dealer and have your vehicle serviced immediately. If not corrected in 30 miles, vehicle will enter the “Engine Will not restart in XXXmi Service DEF See dealer” warning stage and message.

- **Incorrect DEF Detected See Dealer** — This message will display if the DEF system has detected the incorrect fluid has been introduced to the DEF tank. The message will be accompanied by a single chime. We recommend you drive to your nearest authorized dealer and have your vehicle serviced immediately. If not corrected in 30 miles, vehicle will enter the Engine Will not restart in XXX mi Service DEF See dealer warning stage and message.
- **Engine Will Not Restart in XXX mi Service DEF See Dealer** — This message is first displayed if the fault

detected is not serviced after 30 miles of operation. It is also displayed at 250 miles 186 miles and 124 miles. System service is required within the displayed mileage. The message will be displayed in the DID during vehicle start up with an updated distance mileage, and it will be accompanied by a single chime. Starting at 124 miles, remaining range will be continuously displayed while operating the vehicle. Chimes will also accompany the 75, 50 and 25 mile remaining distances. We recommend you drive to your nearest authorized dealer and have your vehicle serviced immediately.

- **Engine Will Not Restart Service DEF System See Dealer** — This message will display if DEF system issue detected is not serviced during the allowed period. Your engine will not restart unless your vehicle is serviced by your authorized dealer. This message will be displayed when under 1 mile until engine will not start and each time the vehicle is started, and will

be continuously displayed. The message will be accompanied by a single chime. Your Malfunction Indicator Light will be continuously illuminated. We highly recommend you drive to your nearest authorized dealer if the message appears while engine is running.

- **Engine Will Not Start Service DEF System See Dealer** — This message will display when the fault detected is not serviced after the Engine will not restart Service DEF System See Dealer message is displayed on the next subsequent restart. Your engine will not start unless your vehicle is serviced by your authorized dealer. The message will be accompanied by a single chime. Your Malfunction Indicator Light will be continuously illuminated. If the message appears and you can not start the engine, we recommend you have your vehicle towed to your nearest authorized dealer immediately.

**NOTE:**

- The gauge may take up to five seconds to update after adding a gallon or more of Diesel Exhaust Fluid (DEF) to the DEF tank. If you have a fault related to the DEF system, the gauge may not update to the new level. See your authorized dealer for service.
- The DEF gauge may also not immediately update after a refill if the temperature of the DEF fluid is below 12F (-11C). The DEF line heater will possibly warm up the DEF fluid and allow the gauge to update after a period of run time. Under very cold conditions, it is possible that the gauge may not reflect the new fill level for several drives.

# STARTING AND OPERATING

## CONTENTS

---

■ STARTING PROCEDURES . . . . .	.31	□ Cooling System Tips — Automatic Transmission. . . . .	.39
□ Automatic Transmission . . . . .	.32	■ ENGINE BLOCK HEATER — IF EQUIPPED . . . . .	.40
□ Extreme Cold Weather . . . . .	.32	■ FUEL REQUIREMENTS . . . . .	.41
□ Normal Starting Procedure — Keyless Enter-N-Go. . . . .	.33	□ Fuel Specifications . . . . .	.42
□ Starting Fluids . . . . .	.34	□ Biodiesel Fuel Requirements. . . . .	.43
■ NORMAL OPERATION . . . . .	.35	■ TRAILER TOWING . . . . .	.46
□ Cold Weather Precautions . . . . .	.35	□ Common Towing Definitions . . . . .	.46
□ Engine Idling . . . . .	.38	□ Trailer Hitch Classification . . . . .	.49
□ Stopping The Engine . . . . .	.38		

## 30 STARTING AND OPERATING

- Trailer Towing Weights (Maximum Trailer Weight Ratings) . . . . .51
- Trailer And Tongue Weight . . . . .51
- Towing Requirements . . . . .52
- Towing Tips . . . . .57
- DIESEL EXHAUST FLUID . . . . .59
  - System Overview . . . . .59
- ADDING FUEL . . . . .60
  - Avoid Using Contaminated Fuel . . . . .63
  - Bulk Fuel Storage — Diesel Fuel . . . . .63
  - Diesel Exhaust Fluid Storage . . . . .64
  - Adding Diesel Exhaust Fluid . . . . .65



## STARTING PROCEDURES

Before starting your vehicle, adjust your seat, both inside and outside mirrors, and fasten your seat belts.

The starter is allowed to crank for up to 30-second intervals. Waiting a few minutes between such intervals will protect the starter from overheating.

### WARNING!

- Before exiting a vehicle, always shift the automatic transmission into PARK and apply the parking brake. Always make sure the keyless ignition node is in the "OFF" mode, remove the Key Fob from the vehicle and lock the vehicle.
- Never leave children alone in a vehicle, or with access to an unlocked vehicle. Leaving children in a vehicle unattended is dangerous for a number of

*(Continued)*

### WARNING! *(Continued)*

reasons. A child or others could be seriously or fatally injured. Children should be warned not to touch the parking brake, brake pedal or the gear selector.

- Do not leave the key fob in or near the vehicle, or in a location accessible to children, and do not leave the ignition of a vehicle equipped with Keyless Enter-N-Go in the ACC or ON/RUN mode. A child could operate power windows, other controls, or move the vehicle.
- Do not leave children or animals inside parked vehicles in hot weather. Interior heat build-up may cause serious injury or death.

NOTE: Engine start up in very low ambient temperature could result in evident white smoke. This condition will disappear as the engine warms up.

**CAUTION!**

- The engine is allowed to crank as long as 30 seconds. If the engine fails to start during this period, please wait at least two minutes for the starter to cool before repeating start procedure.
- If the “Water in Fuel Indicator Light” remains on, **DO NOT START** engine before you drain the water from the fuel filters to avoid engine damage. Refer to “Maintenance Procedures/Draining Fuel/Water Separator Filter” in “Maintaining Your Vehicle” for further information.

**Automatic Transmission**

Start the engine with the transmission gear selector in the PARK position. Apply the brake before shifting to any driving range.

**Extreme Cold Weather**

The engine block heater is a resistance heater installed in the water jacket of the engine. It requires a 110–115 Volt AC electrical outlet with a grounded, three-wire extension cord. Its use is recommended for environments that routinely fall below  $-10^{\circ}\text{F}$  ( $-23^{\circ}\text{C}$ ). It should be used when the vehicle has not been running overnight or longer periods and should be plugged in two hours prior to start. Its use is required for cold starts with temperatures under  $-20^{\circ}\text{F}$  ( $-28^{\circ}\text{C}$ ).

**NOTE:** The engine block heater cord is a factory installed option. If your vehicle is not equipped, heater cords are available from your authorized MOPAR dealer.

- A 12 Volt heater built into the fuel filter housing aids in preventing fuel gelling. It is controlled by a built-in thermostat.

- A Diesel Pre-Heat system both improves engine starting and reduces the amount of white smoke generated by a warming engine.

### Normal Starting Procedure — Keyless Enter-N-Go

Observe the instrument panel cluster lights when starting the engine.

**NOTE:** Normal starting of either a cold or a warm engine is obtained without pumping or pressing the accelerator pedal

1. Always apply the parking brake.
2. Press and hold the brake pedal while pushing the ENGINE START/STOP button once.

**NOTE:** A delay of the start of up to five seconds is possible under very cold conditions. The "Wait to Start" telltale will be illuminated during the pre-heat process, When the engine Wait To Start light goes off the engine will automatically crank.

### CAUTION!

If the "Water in Fuel Indicator Light" remains on, **DO NOT START** the engine before you drain the water from the fuel filters to avoid engine damage. Refer to "Maintenance Procedures/Draining Fuel/Water Separator Filter" in "Maintaining Your Vehicle" for further information.

3. The system will automatically engage the starter to crank the engine. If the vehicle fails to start, the starter will disengage automatically after 25 seconds.

## 34 STARTING AND OPERATING

4. If you wish to stop the cranking of the engine prior to the engine starting, push the button again.
5. Check that the oil pressure warning light has turned off.
6. Release the parking brake.

### Starting Fluids

The engine is equipped with a glow plug preheating system. If the instructions in this manual are followed, the engine should start in all conditions and no type of starting fluid should be used.

#### **WARNING!**

- Do not leave children or animals inside parked vehicles in hot weather. Interior heat build up may cause serious injury or death.

*(Continued)*

#### **WARNING! (Continued)**

- When leaving the vehicle, always make sure the keyless ignition node is in the "OFF" mode, remove the key fob from the vehicle and lock the vehicle.
- Never leave children alone in a vehicle, or with access to an unlocked vehicle. Allowing children to be in a vehicle unattended is dangerous for a number of reasons. A child or others could be seriously or fatally injured. Children should be warned not to touch the parking brake, brake pedal or the gear selector.
- Do not leave the key fob in or near the vehicle, or in a location accessible to children, and do not leave the ignition of a vehicle equipped with Keyless Enter-N-Go in the ACC or ON/RUN mode. A child could operate power windows, other controls, or move the vehicle.

## NORMAL OPERATION

Observe the following when the diesel engine is operating.

- All message center lights are off.
- Malfunction Indicator Light (MIL) is off.
- Engine Oil Pressure telltale is not illuminated.
- Voltmeter operation:

The voltmeter may show a gauge fluctuation at various engine temperatures. This is caused by the glow plug heating system. The number of cycles and the length of the cycling operation is controlled by the engine control

module. Glow plug heater operation can run for several minutes, once the heater operation is complete the voltmeter needle will stabilize.

## Cold Weather Precautions

Operation in ambient temperature below 32°F (0°C) may require special considerations. The following charts suggest these options:

## Fuel Operating Range

**NOTE:** Use “Ultra Low Sulfur Diesel Fuels” **ONLY**.

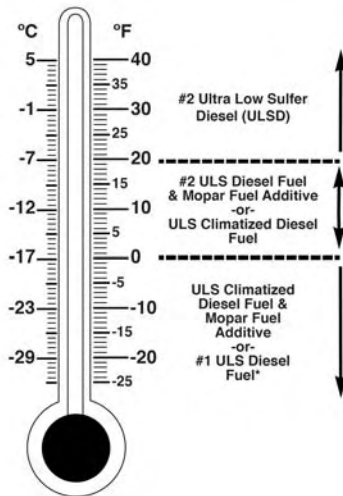

Fuel Operating Range Chart

\*No. 1 Ultra Low Sulfur Diesel Fuel should only be used where extended arctic conditions (0°F/-18°C) exist”.

#### NOTE:

- Use of Climatized Ultra Low Sulfur Diesel Fuel or Number 1 Ultra Low Sulfur Diesel Fuel results in a noticeable decrease in fuel economy.
- Climatized Ultra Low Sulfur Diesel Fuel is a blend of Number 2 Ultra Low Sulfur and Number 1 Ultra Low Sulfur Diesel Fuels which reduces the temperature at which wax crystals form in fuel.
- The fuel grade should be clearly marked on the pump at the fuel station.
- The engine requires the use of **“Ultra Low Sulfur Diesel Fuel”**. Use of incorrect fuel could result in engine and exhaust system damage. Refer to “Fuel Requirements” in “Starting And Operating” for further information.

- If climatized or diesel Number 1 ULSD fuel is not available, and you are operating below (20°F/-6°C), in sustained arctic conditions, Mopar Premium Diesel Fuel Treatment (or equivalent) is recommended to avoid gelling (see Fuel Operating Range Chart).

#### Engine Oil Usage

Refer to “Maintenance Procedures” in “Maintaining Your Vehicle” for the correct engine oil viscosity.

#### Engine Warm-Up

Avoid full throttle operation when the engine is cold. When starting a cold engine, bring the engine up to operating speed slowly to allow the oil pressure to stabilize as the engine warms up.

If temperatures are below 32°F (0°C), operate the engine at moderate speeds for five minutes before full loads are applied.

## Engine Idling

Avoid prolonged idling, long periods of idling may be harmful to your engine because combustion chamber temperatures can drop so low that the fuel may not burn completely. Incomplete combustion allows carbon and varnish to form on piston rings, cylinder head valves, and injector nozzles. Also, the unburned fuel can enter the crankcase, diluting the oil and causing rapid wear to the engine.

## Stopping The Engine

After full load operation, idle the engine for a few minutes before shutting it down. This idle period will allow the lubricating oil and coolant to carry excess heat away from the turbocharger.

**NOTE:** Refer to the following chart for proper engine shutdown.

Driving Condition	Load	Turbocharger Temperature	Idle Time (min.) Before Engine Shutdown
Stop and Go	Empty	Cool	None
Stop and Go	Medium		0.5
Highway Speeds	Medium	Warm	1.0
City Traffic	Maximum GCWR		1.5
Highway Speeds	Maximum GCWR		2.0
Uphill Grade	Maximum GCWR	Hot	2.5



**NOTE:** Under certain conditions the engine fan will run after the engine is turned off. These conditions are under high load and high temperature conditions.

### **Cooling System Tips — Automatic Transmission**

To reduce the potential for engine and transmission overheating in high ambient temperature conditions, take the following actions:

- City Driving — When stopped, shift the transmission into NEUTRAL and increase engine idle speed.
- Highway Driving — Reduce your speed.
- Up Steep Hills — Select a lower transmission gear.
- Air Conditioning — Turn it off temporarily.

**NOTE:** If the coolant temperature is too high the A/C will automatically turn off.

### **Do Not Operate The Engine With Low Oil Pressure**

If the low oil pressure warning light turns on while driving, stop the vehicle and shut down the engine as soon as possible. A chime will sound when the light turns on.

**NOTE:** Do not operate the vehicle until the cause is corrected. This light does not show how much oil is in the engine. The engine oil level must be checked under the hood.

#### **CAUTION!**

**If oil pressure falls to less than normal readings, shut the engine off immediately. Failure to do so could result in immediate and severe engine damage.**

### Do Not Operate The Engine With Failed Parts

All engine failures give some warning before the parts fail. Be on the alert for changes in performance, sounds, and visual evidence that the engine requires service. Some important clues are:

- Engine misfiring or vibrating severely.
- Sudden loss of power.
- Unusual engine noises.
- Fuel, oil or coolant leaks.
- Sudden change, outside the normal operating range, in the engine operating temperature.
- Excessive smoke.
- Oil pressure drop.

### ENGINE BLOCK HEATER — IF EQUIPPED

The engine block heater warms engine coolant and permits quicker starts in cold weather. Connect the heater cord to a ground-fault interrupter protected 110–115 Volt AC electrical outlet with a grounded, three-wire extension cord.

Its use is recommended for environments that routinely fall below  $-10^{\circ}\text{F}$  ( $-23^{\circ}\text{C}$ ). It should be used when the vehicle has not been running for long periods of time and should be plugged in two hours prior to start. Its use is required for cold starts with temperatures under  $-20^{\circ}\text{F}$  ( $-28^{\circ}\text{C}$ ).

To ensure reliable starting at these temperatures, use of an externally powered electric engine block heater (available from your authorized dealer) is recommended.

**WARNING!**

**Remember to disconnect the cord before driving. Damage to the 110–115 Volt electrical cord could cause electrocution.**

**NOTE:** The block heater will require 110 Volts AC and 6.5 Amps to activate the heater element.

**FUEL REQUIREMENTS**

Use good quality diesel fuel from a reputable supplier in your vehicle. Federal law requires that you must fuel this vehicle with Ultra Low Sulfur Highway Diesel fuel (15 ppm Sulfur maximum) and prohibits the use of Low Sulfur Highway Diesel fuel (500 ppm Sulfur maximum) to avoid damage to the emissions control system.

For most year-round service, No. 2 diesel fuel meeting ASTM (formerly known as the American Society for Testing and Materials) specification D-975 Grade S15 will

provide good performance. If the vehicle is exposed to extreme cold (below 20°F or -7°C), or is required to operate at colder-than-normal conditions for prolonged periods, use climatized No. 2 diesel fuel or dilute the No. 2 diesel fuel with 50% No. 1 diesel fuel. This will provide better protection from fuel gelling or wax-plugging of the fuel filters.

**WARNING!**

**Do not use alcohol or gasoline as a fuel blending agent. They can be unstable under certain conditions and hazardous or explosive when mixed with diesel fuel.**

Diesel fuel is seldom completely free of water. To prevent fuel system trouble, drain the accumulated water from the fuel/water separator using the fuel/water separator drain provided on the fuel filter housing. If you buy good quality fuel and follow the cold weather advice above,

fuel conditioners should not be required in your vehicle. If available in your area, a high cetane “premium” diesel fuel may offer improved cold-starting and warm-up performance.

### CAUTION!

If the “Water in Fuel Indicator Light” remains on, **DO NOT START** engine before you drain the water from the fuel filter(s) to avoid engine damage. Refer to “Maintenance Procedures/Draining Fuel/Water Separator Filter” in “Maintaining Your Vehicle” for further information.

### Fuel Specifications

This diesel engine has been developed to take advantage of the high energy content and generally lower cost No. 2 Ultra Low Sulfur diesel fuel or No. 2 Ultra Low Sulfur climatized diesel fuels.

### NOTE:

- If you accidentally fill the fuel tank with gasoline on your diesel vehicle, do not start the engine. Damage to the engine and fuel system could occur. Please call your authorized dealer for service.
- A maximum blend of 5% biodiesel meeting ASTM specification D-975 may be used with your diesel engine without any adjustments to regular service schedules.
- Commercially available fuel additives are not necessary for the proper operation of your diesel engine.
- No. 1 Ultra Low Sulfur diesel fuel should only be used where extended arctic conditions (-10°F or -23°C) exist.

## Biodiesel Fuel Requirements

A maximum blend of 5% biodiesel meeting ASTM specification D975 is recommended for use with your diesel engine. If frequent operation with Biodiesel blends that are between 6% and 20% (B6–B20) is desired, the maintenance schedule is subject to shorter intervals.

The oil and filter change along with fuel filter replacement is subject to shorter intervals when operating your engine on biodiesel greater than 5%. Do not use biodiesel greater than 20%.

For regular use of biodiesel blends between 6% and 20% (B6–B20) it is important that you understand and comply with these requirements. Refer to the “Maintenance Chart” in the “Maintenance Schedules” section for further direction.

### CAUTION!

**Failure to comply with Oil Change requirements for vehicles operating on biodiesel blends between 6% and 20% (B6–B20) will result in premature engine wear. Such wear is not covered by the New Vehicle Limited Warranty.**

Biodiesel is a fuel produced from renewable resources typically derived from animal fat, rapeseed oil (Rapeseed Methyl Ester (RME) base), or soybean oil (Soy Methyl Ester (SME or SOME) base).

Biodiesel fuel has inherent limitations which require that you understand and adhere to the following requirements if you use blends of Biodiesel between 6% and 20% (B6–B20). There are no unique restrictions for the use of B5.

**CAUTION!**

Use of blends greater than 20% is not approved. Use of blends greater than 20% can result in engine damage. Such damage is not covered by the New Vehicle Limited Warranty.

**Biodiesel Fuel Properties — Low Ambient Temperatures**

Biodiesel fuel may gel or solidify at low ambient temperatures, which may pose problems for both storage and operation. Precautions can be necessary at low ambient temperatures, such as storing the fuel in a heated building or a heated storage tank, or using cold temperature additives.

**Fuel Quality — Must Comply With ASTM Standards**

The quality of Biodiesel fuel may vary widely. Only fuel produced by a BQ9000 supplier to the following specifications may be blended to meet Biodiesel blend B6 – B20 fuel meeting ASTM specification D-7467:

- Petrodiesel fuel meeting ASTM specification D-975 and Biodiesel fuel (B100) meeting ASTM specification D-6751

**Fuel Oxidation Stability — Must Use Fuel Within Six Months Of Manufacture**

Biodiesel fuel has poor oxidation stability which can result in long term storage problems. Fuel produced to approved ASTM standards, if stored properly, provides for protection against fuel oxidation for up to six months.

### **Fuel Water Separation — Must Use MOPAR Approved Fuel Filter Elements**

Biodiesel fuel has a natural affinity to water and water accelerates microbial growth. Your MOPAR filtration system is designed to provide adequate fuel water separation capabilities.

### **Fuel In Oil Dilution — Must Adhere To Required Oil Change Interval**

Fuel dilution of lubricating oil has been observed with the use of Biodiesel fuel. Fuel in oil must not exceed 5%. To ensure this limit is met your oil change interval must be maintained with in the suggested schedule. The regular use of biodiesel between 6% and 20% requires intervals shorter than the outlined 10,000 miles and must not exceed the suggested schedule. When routinely operating on biodiesel between 6% and 20%, oil and filter replacement intervals must not exceed 8,000 Miles or 6 months, which ever comes first.

### **Biodiesel Fuel Filter Change Intervals**

The use of biodiesel requires intervals shorter than the outlined 30,000 miles (48 280 km) and must not exceed the suggested schedule. When operating on biodiesel between 6% and 20%, fuel filter replacement intervals must not exceed 20,000 Miles (40 233 km).

**NOTE:** Under no circumstances should oil change intervals exceed 8,000 miles (12 875 km) or 6 months, if regular operation occurs with 6% - 20% biodiesel blends. Under no circumstances should fuel filter intervals exceed 20,000 miles (40 233 km), if regular operation occurs with 6% - 20% biodiesel blends. Failure to comply with these Oil Change and fuel filter requirements for vehicles operating on biodiesel blends up to B20 may result in premature engine wear. Such wear is not covered by the New Vehicle Limited Warranty. The engine may suffer severe damage if operated with concentrations of biodiesel higher than 20%.

## TRAILER TOWING

In this section you will find safety tips and information on limits to the type of towing you can reasonably do with your vehicle. Before towing a trailer, carefully review this information to tow your load as efficiently and safely as possible.

To maintain the New Vehicle Limited Warranty coverage, follow the requirements and recommendations in this manual concerning vehicles used for trailer towing.

### Common Towing Definitions

The following trailer towing related definitions will assist you in understanding the following information:

#### Gross Vehicle Weight Rating (GVWR)

The GVWR is the total allowable weight of your vehicle. This includes driver, passengers, cargo and tongue weight. The total load must be limited so that you do not

exceed the GVWR. Refer to “Vehicle Loading/Vehicle Certification Label” in “Starting And Operating” for further information.

#### Gross Trailer Weight (GTW)

The GTW is the weight of the trailer plus the weight of all cargo, consumables and equipment (permanent or temporary) loaded in or on the trailer in its “loaded and ready for operation” condition.

The recommended way to measure GTW is to put your fully loaded trailer on a vehicle scale. The entire weight of the trailer must be supported by the scale.

### WARNING!

**If the gross trailer weight is 5,000 lbs (2 267 kg) or more, it is recommended to use a weight-distributing hitch to ensure stable handling of your vehicle. If**

*(Continued)*



**WARNING! (Continued)**

you use a standard weight-carrying hitch, you could lose control of your vehicle and cause a collision.

**Gross Combination Weight Rating (GCWR)**

The GCWR is the total permissible weight of your vehicle and trailer when weighed in combination.

**Gross Axle Weight Rating (GAWR)**

The GAWR is the maximum capacity of the front and rear axles. Distribute the load over the front and rear axles evenly. Make sure that you do not exceed either front or rear GAWR. Refer to “Vehicle Loading/Vehicle Certification Label” in “Starting And Operating” for further information.

**WARNING!**

It is important that you do not exceed the maximum front or rear GAWR. A dangerous driving condition can result if either rating is exceeded.

**Tongue Weight (TW)**

The tongue weight is the downward force exerted on the hitch ball by the trailer. You must consider this as part of the load on your vehicle.

**Frontal Area**

The frontal area is the maximum height multiplied by the maximum width of the front of a trailer.

**Trailer Sway Control**

The trailer sway control can be a mechanical telescoping link that can be installed between the hitch receiver and

the trailer tongue that typically provides adjustable friction associated with the telescoping motion to dampen any unwanted trailer swaying motions while traveling.

If equipped, the electronic Trailer Sway Control (TSC) recognizes a swaying trailer and automatically applies individual wheel brakes and/or reduces engine power to attempt to eliminate the trailer sway.

### **Weight-Carrying Hitch**

A weight-carrying hitch supports the trailer tongue weight, just as if it were luggage located at a hitch ball or some other connecting point of the vehicle. These kinds of hitches are the most popular on the market today and they are commonly used to tow small and medium sized trailers.

### **Weight-Distributing Hitch**

A weight-distributing system works by applying leverage through spring (load) bars. They are typically used for heavier loads to distribute trailer tongue weight to the tow vehicle's front axle and the trailer axle(s). When used in accordance with the manufacturer's directions, it provides for a more level ride, offering more consistent steering and brake control thereby enhancing towing safety. The addition of a friction/hydraulic sway control also dampens sway caused by traffic and crosswinds and contributes positively to tow vehicle and trailer stability. Trailer sway control and a weight distributing (load equalizing) hitch are recommended for heavier Tongue Weights (TW) and may be required depending on vehicle and trailer configuration/loading to comply with Gross Axle Weight Rating (GAWR) requirements.

**WARNING!**

- An improperly adjusted Weight Distributing Hitch system may reduce handling, stability, braking performance, and could result in a collision.
- Weight Distributing Systems may not be compatible with Surge Brake Couplers. Consult with your hitch and trailer manufacturer or a reputable Recreational Vehicle dealer for additional information.

**Trailer Hitch Classification**

The following chart provides the industry standard for the maximum trailer weight a given trailer hitch class can tow and should be used to assist you in selecting the correct trailer hitch for your intended towing condition.

**Trailer Hitch Classification Definitions**

<b>Class</b>	<b>Max. Trailer Hitch Industry Standards</b>
Class I - Light Duty	2,000 lbs (907 kg)
Class II - Medium Duty	3,500 lbs (1 587 kg)
Class III - Heavy Duty	5,000 lbs (2 267 kg)
Class IV - Extra Heavy Duty	10,000 lbs (4 535 kg)

Refer to the “Trailer Towing Weights (Maximum Trailer Weight Ratings)” chart for the Maximum Gross Trailer Weight (GTW) towable for your given drivetrain.

All trailer hitches should be professionally installed on your vehicle.

## Trailer Towing Weights (Maximum Trailer Weight Ratings)

The following chart provides the maximum trailer weight ratings towable for your given drivetrain:

Engine	Model	Frontal Area	Max. GTW (Gross Trailer Wt.)	Max. Trailer Tongue Wt. (See Note)
3.0L Diesel	4x2	55 sq ft (5.11 sq m)	7,400 lbs (3 356 kg)	740 lbs (335 kg)
3.0L Diesel	4x4	55 sq ft (5.11 sq m)	7,200 lbs (3 265 kg)	720 lbs (326 kg)
Refer to local laws for maximum trailer towing speeds.				

**NOTE:** The trailer tongue weight must be considered as part of the combined weight of occupants and cargo, and should never exceed the weight referenced on the Tire and Loading Information placard. Refer to “Tire Safety Information” in “Starting and Operating” in your owners manual for further information. The addition of passengers and cargo may require reducing trailer tongue load and Gross Trailer Weight (GTW). Redistributing cargo (to the trailer) may be necessary to avoid exceeding Rear Gross Axle Weight Rating (GAWR) of 3,700 lbs (1 678 kg).

### Trailer And Tongue Weight

Never exceed the maximum tongue weight stamped on your trailer hitch.

Consider the following items when computing the weight on the rear axle of the vehicle:

- The tongue weight of the trailer
- The weight of any other type of cargo or equipment put in or on your vehicle

- The weight of the driver and all passengers

**NOTE:** Remember that everything put into or on the trailer adds to the load on your vehicle. Also, additional factory-installed options or dealer-installed options must be considered as part of the total load on your vehicle. Refer to “Tire Safety Information/Tire and Loading Information Placard” in “Starting And Operating” for further information.

### Towing Requirements

To promote proper break-in of your new vehicle drivetrain components, the following guidelines are recommended.

#### CAUTION!

- **Do not tow a trailer at all during the first 500 miles (805 km) the new vehicle is driven. The engine, axle or other parts could be damaged.**
- **Then, during the first 500 miles (805 km) that a trailer is towed, do not drive over 50 mph (80 km/h) and do not make starts at full throttle. This helps the engine and other parts of the vehicle wear in at the heavier loads.**

Perform the maintenance listed in the “Maintenance Schedule”. Refer to “Maintenance Schedule” for the proper maintenance intervals. When towing a trailer, never exceed the GAWR or GCWR ratings.

**WARNING!**

Improper towing can lead to a collision. Follow these guidelines to make your trailer towing as safe as possible:

- Make certain that the load is secured in the trailer and will not shift during travel. When trailering cargo that is not fully secured, dynamic load shifts can occur that may be difficult for the driver to control. You could lose control of your vehicle and have a collision.
- When hauling cargo or towing a trailer, do not overload your vehicle or trailer. Overloading can cause a loss of control, poor performance or damage to brakes, axle, engine, transmission, steering, suspension, chassis structure or tires.

*(Continued)*

**WARNING! (Continued)**

- Safety chains must always be used between your vehicle and trailer. Always connect the chains to the hook retainers of the vehicle hitch. Cross the chains under the trailer tongue and allow enough slack for turning corners.
- Vehicles with trailers should not be parked on a grade. When parking, apply the parking brake on the tow vehicle. Put the tow vehicle transmission in PARK. For four-wheel drive vehicles, make sure the transfer case is not in NEUTRAL. Always, block or "chock" the trailer wheels.
- GCWR must not be exceeded.

*(Continued)*

**WARNING! (Continued)**

- **Total weight must be distributed between the tow vehicle and the trailer such that the following four ratings are not exceeded:**
  1. GVWR
  2. GTW
  3. GAWR
  4. Tongue weight rating for the trailer hitch utilized.

**Towing Requirements — Tires**

- Do not attempt to tow a trailer while using a compact spare tire.
- Proper tire inflation pressures are essential to the safe and satisfactory operation of your vehicle. Refer to “Tires – General Information” in your Tire Information

Supplement or “Starting And Operating” in your Owner’s Manual for proper tire inflation procedures.

- Check the trailer tires for proper tire inflation pressures before trailer usage.
- Check for signs of tire wear or visible tire damage before towing a trailer. Refer to “Tires – General Information” in your Tire Information Supplement or “Starting And Operating” in your Owner’s Manual for the proper inspection procedure.
- When replacing tires, refer to “Tires – General Information” in your Tire Information Supplement or “Starting And Operating” in your Owner’s Manual for the proper tire replacement procedures. Replacing tires with a higher load carrying capacity will not increase the vehicle’s GVWR and GAWR limits.



## Towing Requirements — Trailer Brakes

### WARNING!

- Do not connect trailer brakes to your vehicle's hydraulic brake lines. It can overload your brake system and cause it to fail. You might not have brakes when you need them and could have an accident.
- Towing any trailer will increase your stopping distance. When towing you should allow for additional space between your vehicle and the vehicle in front of you. Failure to do so could result in an accident.

### CAUTION!

If the trailer weighs more than 1,000 lbs (453 kg) loaded, it should have its own brakes and they should be of adequate capacity. Failure to do this could lead to accelerated brake lining wear, higher brake pedal effort, and longer stopping distances.

- Do **not** interconnect the hydraulic brake system or vacuum system of your vehicle with that of the trailer. This could cause inadequate braking and possible personal injury.
- An electronically actuated trailer brake controller is required when towing a trailer with electronically actuated brakes. When towing a trailer equipped with a hydraulic surge actuated brake system, an electronic brake controller is not required.

- Trailer brakes are recommended for trailers over 1,000 lbs (453 kg) and required for trailers in excess of 1,653 lbs (749 kg).

### Towing Requirements — Trailer Lights And Wiring

Whenever you pull a trailer, regardless of the trailer size, stoplights and turn signals on the trailer are required for motoring safety.

The Trailer Tow Package may include a four- and seven-pin wiring harness. Use a factory approved trailer harness and connector.

**NOTE:** Do not cut or splice wiring into the vehicles wiring harness.

The electrical connections are all complete to the vehicle but you must mate the harness to a trailer connector. Refer to the following illustrations.

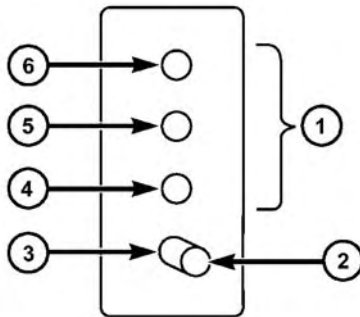

057003766

### Four-Pin Connector

- 1 — Female Pins
- 2 — Male Pin
- 3 — Ground

- 4 — Park
- 5 — Left Stop/Turn
- 6 — Right Stop/Turn

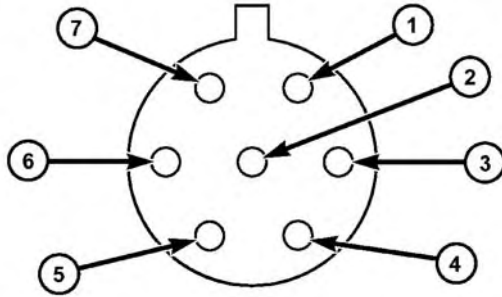

057003765

### Seven-Pin Connector

- |                     |                    |
|---------------------|--------------------|
| 1 — Battery         | 5 — Ground         |
| 2 — Backup Lamps    | 6 — Left Stop/Turn |
| 3 — Right Stop/Turn | 7 — Running Lamps  |
| 4 — Electric Brakes |                    |

### Towing Tips

Before setting out on a trip, practice turning, stopping and backing the trailer up in an area away from heavy traffic.

### Automatic Transmission

The DRIVE range can be selected when towing. The transmission controls include a drive strategy to avoid frequent shifting when towing. However, if frequent shifting does occur while in DRIVE, you can use the AutoStick shift control or manual gate of shifter to manually select a lower gear.

**NOTE:** Using a lower gear while operating the vehicle under heavy loading conditions, will improve performance and extend transmission life by reducing excessive shifting and heat buildup. This action will also provide better engine braking.

### **Autostick**

- When using the AutoStick shift control, select the highest gear that allows for adequate performance and avoids frequent downshifts. For example, choose “5” if the desired speed can be maintained. Choose “4” or “3” if needed to maintain the desired speed.
- To prevent excess heat generation, avoid continuous driving at high RPM. Reduce vehicle speed as necessary to avoid extended driving at high RPM. Return to a higher gear or vehicle speed when grade and road conditions allow.

### **Electronic Speed Control — If Equipped**

- Do not use in hilly terrain or with heavy loads.
- When using the speed control, if you experience speed drops greater than 10 mph (16 km/h), disengage until you can get back to cruising speed.

- Use speed control in flat terrain and with light loads to maximize fuel efficiency.

### **Cooling System**

To reduce potential for engine and transmission overheating, take the following actions:

#### **City Driving**

When stopped for short periods of time, shift the transmission into NEUTRAL and increase engine idle speed.

#### **Highway Driving**

Reduce speed.

#### **Air Conditioning**

Turn off temporarily.

## DIESEL EXHAUST FLUID

Your vehicle is equipped with a Selective Catalytic Reduction system to meet the very stringent diesel emissions standards required by the Environmental Protection Agency.

The purpose of the SCR system is to reduce levels of NO<sub>x</sub> (oxides of nitrogen emitted from engines) that are harmful to our health and the environment to a near-zero level. Small quantities of Diesel Exhaust Fluid (DEF) is injected into the exhaust upstream of a catalyst where, when vaporized, it converts smog-forming nitrogen oxides (NO<sub>x</sub>) into harmless nitrogen (N<sub>2</sub>) and water vapor (H<sub>2</sub>O), two natural components of the air we breathe. You can operate with the comfort that your vehicle is contributing to a cleaner, healthier world environment for this and generations to come.

## System Overview

This vehicle is equipped with a Diesel Exhaust Fluid (DEF) injection system and a Selective Catalytic Reduction (SCR) catalyst to meet the emission requirements.

The DEF injection system consists of the following components:

- DEF tank
- DEF pump
- DEF injector
- Electronically-heated DEF lines
- NO<sub>x</sub> sensors
- Temperature sensors
- SCR catalyst

The DEF injection system and SCR catalyst enable the achievement of diesel emissions requirements; while maintaining outstanding fuel economy, drivability, torque and power ratings.

Refer to “Driver Information Display (DID)” in “Understanding Your Instrument Panel” for system messages and warnings.

**NOTE:**

- Your vehicle is equipped with a DEF injection system. You may occasionally hear an audible clicking noise from under the vehicle at a stop. This is normal operation.
- The DEF pump will run for a period of time after engine shutdown to purge the DEF system. This is normal operation and may be audible from the rear of the vehicle.

**ADDING FUEL**

1. Press the fuel filler door release switch (located under the headlamp switch).



**Fuel Filler Door Release Switch**

2. Open the fuel filler door.

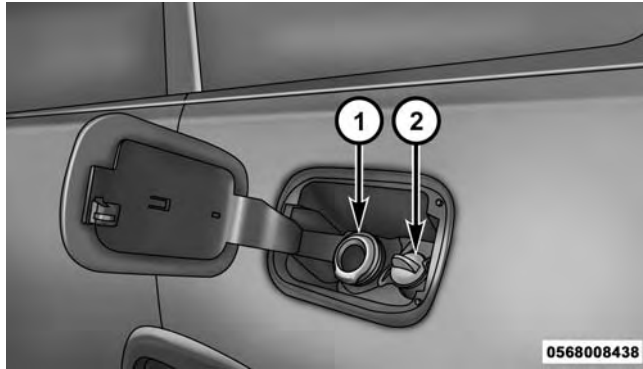

**Fuel and Diesel Exhaust Fluid Fill Location**

1 — Fuel Fill Location

2 — Diesel Exhaust Fluid Fill Location

**NOTE:** There is no fuel filler cap. A flapper door inside the filler pipe seals the system.

3. Insert the fuel nozzle fully into the filler pipe – the nozzle opens and holds the flapper door while refueling.
4. Fill the vehicle with fuel – when the fuel nozzle “clicks” or shuts off the fuel tank is full.
5. Remove the fuel nozzle and close the fuel door.

### Emergency Fuel Can Refueling

Most fuel cans will not open the flapper door.

A funnel is provided to open the flapper door to allow emergency refueling with a fuel can.

1. Retrieve funnel from the spare tire kit.

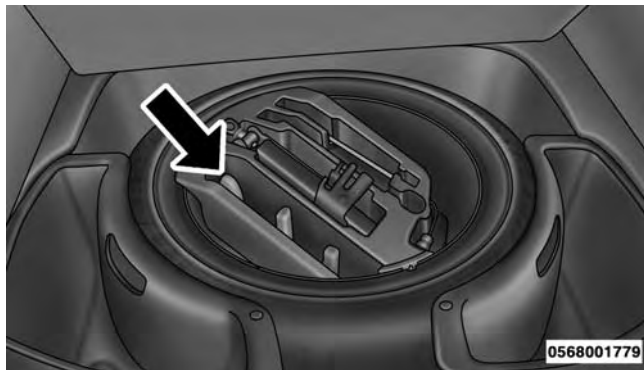

**Fuel Fill Funnel**

2. Insert funnel into same filler pipe opening as the fuel nozzle.

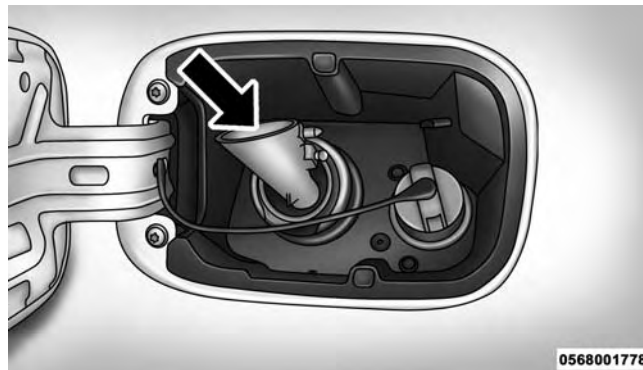

**Emergency Fuel Fill Location**

- NOTE:** Ensure funnel is inserted fully to hold flapper door open.
3. Pour fuel into funnel opening.
  4. Remove funnel from filler pipe, clean off prior to putting back in the spare tire kit.



**CAUTION!**

To avoid fuel spillage and overfilling, do not “top off” the fuel tank after filling.

**WARNING!**

- Never have any smoking materials lit in or near the vehicle when the fuel door is open or the tank is being filled.
- Never add fuel when the engine is running. This is in violation of most state and federal fire regulations and may cause the “Malfunction Indicator Light” to turn on.
- A fire may result if fuel is pumped into a portable container that is inside of a vehicle. You could be burned. Always place fuel containers on the ground while filling.

**Avoid Using Contaminated Fuel**

Fuel that is contaminated by water or dirt can cause severe damage to the engine fuel system. Proper maintenance of the engine fuel filter and fuel tank is essential. Refer to “Maintenance Procedures” in “Maintaining Your Vehicle” for further information.

**Bulk Fuel Storage — Diesel Fuel**

If you store quantities of fuel, good maintenance of the stored fuel is also essential. Fuel contaminated with water will promote the growth of “microbes.” These microbes form “slime” that will clog the fuel filtration system and lines. Drain condensation from the supply tank and change the line filter on a regular basis.

**NOTE:** When a diesel engine is allowed to run out of fuel, air is pulled into the fuel system.

If the vehicle will not start, refer to “Maintenance Procedures/Priming If The Engine Has Run Out Of Fuel” in “Maintaining Your Vehicle” for further information.

**WARNING!**

**Do not open the high pressure fuel system with the engine running. Engine operation causes high fuel pressure. High pressure fuel spray can cause serious injury or death.**

**Diesel Exhaust Fluid Storage**

Diesel Exhaust Fluid (DEF) is considered a very stable product with a long shelf life. If DEF is kept in temperatures between 10° and 90°F (-12° and 32°C), it will last a minimum of one year.

DEF is subject to freezing at the lowest temperatures. For example, DEF may freeze at temperatures at or below 12° F (-11° C). The system has been designed to operate in this environment.

**NOTE:** When working with DEF, it is important to know that:

- Any containers or parts that come into contact with DEF must be DEF compatible (plastic or stainless steel). Copper, brass, aluminum, iron or non-stainless steel should be avoided as they are subject to corrosion by DEF.
- If DEF is spilled, it should be wiped up completely.

## Adding Diesel Exhaust Fluid

The DEF gauge (located on the Driver Information Display (DID display)) will display the level of DEF remaining in the tank. Refer to “Driver Information Display (DID)” in “Understanding Your Instrument Panel” for further information.

**NOTE:** Driving conditions (altitude, vehicle speed, load, etc.) will effect the amount of DEF that is used in your vehicle.

### DEF Fill Procedure

**NOTE:** Refer to “Fluids, Lubricants, and Genuine Parts” in “Maintaining Your Vehicle” for the correct fluid type.

1. Remove cap from DEF fill inlet (located in fuel door).

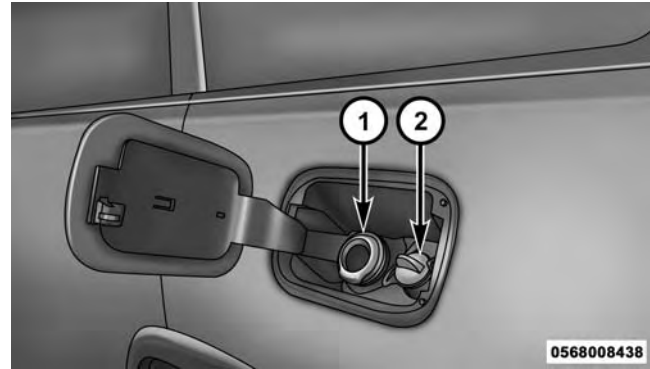

### Fuel and Diesel Exhaust Fluid Fill Location

1 — Fuel Fill Location

2 — Diesel Exhaust Fluid Fill Location

2. Insert DEF fill adapter/nozzle into DEF fill inlet.

**NOTE:**

- The DEF gauge may take up to five seconds to update after adding a gallon or more of Diesel Exhaust Fluid (DEF) to the DEF tank. If you have a fault related to the DEF system, the gauge may not update to the new level. See your authorized dealer for service.
- The DEF gauge may also not immediately update after a refill if the temperature of the DEF fluid is below 12F (-11C). The DEF line heater will possibly warm up the DEF fluid and allow the gauge to update after a period of run time. Under very cold conditions, it is possible that the gauge may not reflect the new fill level for several drives.

**CAUTION!**

- To avoid DEF spillage, and possible damage to the DEF tank from overfilling, do not “top off” the DEF tank after filling.
- **DO NOT OVERFILL.** DEF will freeze below 12°F (-11°C). The DEF system is designed to work in temperatures below the DEF freezing point, however, if the tank is overfilled and freezes, the system could be damaged.
- When DEF is spilled, clean the area immediately with water and use an absorbent material to soak up the spills on the ground.
- Do not attempt to start your engine if DEF is accidentally added to the diesel fuel tank as it can result in severe damage to your engine, including but not limited to failure of the fuel pump and injectors.

*(Continued)*

**CAUTION!** *(Continued)*

- Never add anything other than DEF to the tank – especially any form of hydrocarbon such as diesel fuel, fuel system additives, gasoline, or any other petroleum-based product. Even a very small amount of these (less than 100 parts per million or less than 1 oz. per 78 gallons) will contaminate the entire DEF system and will require replacement. If owners use a container, funnel or nozzle when refilling the tank, it should either be new or one that is has only been used for adding DEF. MOPAR provides an attachable nozzle with its DEF for this purpose.

3. Stop filling the DEF tank immediately when any of the following happen: DEF stops flowing from the fill bottle into the DEF fill inlet, DEF splashes out the fill inlet, or a DEF pump nozzle automatically shuts off.
4. Reinstall cap onto DEF fill inlet.



# MAINTAINING YOUR VEHICLE

## CONTENTS

---

■ ENGINE COMPARTMENT — 3.0L DIESEL . . . . .	.70	□ Maintenance-Free Batteries . . . . .	.83
■ MAINTENANCE PROCEDURES . . . . .	.71	□ Cooling System . . . . .	.84
□ Engine Oil . . . . .	.71	□ Charge Air Cooler — Inter-Cooler . . . . .	.90
□ Engine Air Cleaner Filter . . . . .	.74	□ Brake System . . . . .	.90
□ Draining Fuel/Water Separator Filter . . . . .	.77	■ FLUID CAPACITIES . . . . .	.92
□ Underbody Mounted Fuel Filter Replacement . . . . .	.80	■ FLUIDS, LUBRICANTS AND GENUINE PARTS . . . . .	.93
□ Priming If The Engine Has Run Out Of Fuel . . . . .	.81	□ Engine . . . . .	.93
□ Intervention Regeneration Strategy — Message Process Flow . . . . .	.83	□ Chassis . . . . .	.95

## ENGINE COMPARTMENT — 3.0L DIESEL

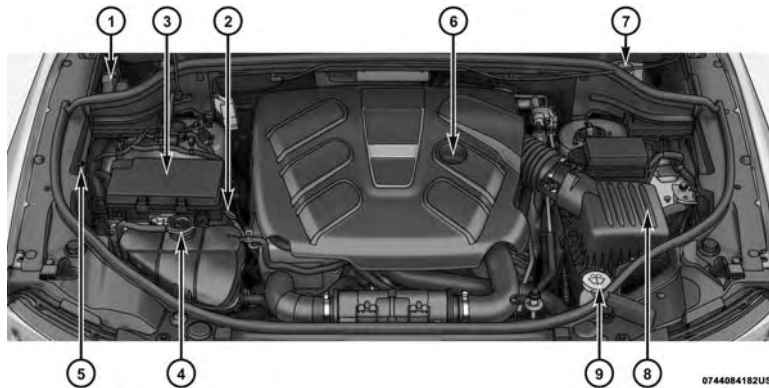

- 1 — Remote Jump Start Positive Terminal
- 2 — Engine Oil Dipstick
- 3 — Power Distribution Center (Fuses)
- 4 — Coolant Pressure Cap (Reservoir)
- 5 — Remote Jump Start Negative Terminal

- 6 — Engine Oil Fill
- 7 — Brake Fluid Reservoir
- 8 — Air Cleaner Filter
- 9 — Washer Fluid Reservoir



## MAINTENANCE PROCEDURES

The pages that follow contain the **required** maintenance services determined by the engineers who designed your vehicle.

Besides those maintenance items specified in the fixed maintenance schedule, there are other components which may require servicing or replacement in the future.

### CAUTION!

- Failure to properly maintain your vehicle or perform repairs and service when necessary could result in more costly repairs, damage to other components or negatively impact vehicle performance. Immediately have potential malfunctions examined by an authorized dealership or qualified repair center.

*(Continued)*

### CAUTION! *(Continued)*

- Your vehicle has been built with improved fluids that protect the performance and durability of your vehicle and also allow extended maintenance intervals. Do not use chemical flushes in these components as the chemicals can damage your engine, transmission, power steering or air conditioning. Such damage is not covered by the New Vehicle Limited Warranty. If a flush is needed because of component malfunction, use only the specified fluid for the flushing procedure.

## Engine Oil

### Engine Oil Selection

For best performance and maximum protection under all types of operating conditions, the manufacturer recommends engine oils that meet the requirements of FCA

Material Standard MS-10902, and that are API CJ-4 certified and meet the requirements of FCA LLC.

### Checking Oil Level

To assure proper lubrication of your vehicle's engine, the engine oil must be maintained at the correct level. Check the oil level at regular intervals. The best time to check the oil level is before starting the engine after it has been parked overnight. When checking oil after operating the engine, first ensure the engine is at full operating temperature, then wait for five minutes after engine shut-down to check the oil.

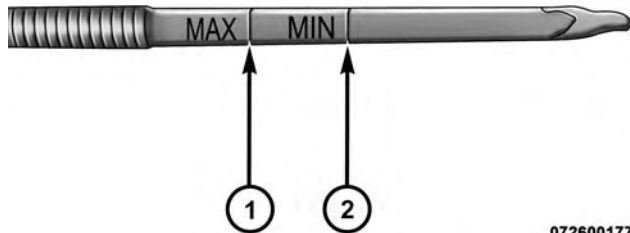

0726001776

1 — MAX Mark

2 — MIN Mark

---

Checking the oil while the vehicle is on level ground will improve the accuracy of the oil level readings. Add oil only when the level on the dipstick is below the “MIN” mark. The total capacity from the MIN mark to the MAX mark is 1.7 qts (1.6L).

### CAUTION!

**Overfilling or underfilling the crankcase will cause oil aeration or loss of oil pressure. This could damage your engine.**

**NOTE:** It is possible for your oil level to be slightly higher than a previous check. This would be due to diesel fuel that may temporarily be in the crankcase due to operation of the diesel particulate filter regeneration strategy. This fuel will evaporate out under normal operation.

Never operate the engine with oil level below the “MIN” mark or above the upper “MAX” mark.

### Change Engine Oil

Refer to the “Maintenance Schedule” for the proper maintenance intervals.

### Engine Oil Viscosity (SAE Grade)

### CAUTION!

**Your vehicle is equipped with an advanced technology Diesel Engine and an emission device designed to limit Diesel Particulate Emissions from being released into the atmosphere. The durability of your engine and life expectancy of this diesel particulate filter emission device is highly dependent on the use of the correct engine oil.**

We recommend you use 5W-40 **synthetic** engine oil such as MOPAR or Shell Rotella that meets FCA Material Standard MS-10902 and the API CJ-4 or ACEA E9/E7 or ACEA A3/B4 engine oil category is required.

### **Materials Added To Engine Oil**

The manufacturer strongly recommends against the addition of any additives (other than leak detection dyes) to the engine oil. Engine oil is an engineered product and its performance may be impaired by supplemental additives.

### **Engine Oil Filter**

Refer to “Fluids, Lubricants, And Genuine Parts” in “Maintaining Your Vehicle” for further information. The engine oil filter should be changed at every engine oil change.

### **Disposing Of Used Engine Oil And Oil Filters**

Care should be taken in disposing of used engine oil and oil filters from your vehicle. Used oil and oil filters, indiscriminately discarded, can present a problem to the environment. Contact your authorized dealer, service station or governmental agency for advice on how and where used oil and oil filters can be safely discarded in your area.

### **Engine Air Cleaner Filter**

Refer to the “Maintenance Schedule” for the proper maintenance intervals.

#### **CAUTION!**

**All air entering the engine intake must be filtered. The abrasive particles in unfiltered air will cause rapid wear to engine components.**

**WARNING!**

The air induction system (air cleaner, hoses, etc.) provides a measure of protection. Do not remove the air induction system (air cleaner, hoses, etc.) unless such removal is necessary for repair or maintenance. Make sure that no one is near the engine compartment before starting the vehicle with the air induction system (air cleaner, hoses, etc.) removed. Failure to do so can result in serious personal injury.

**CAUTION!**

Many aftermarket performance air filter elements do not adequately filter the air entering the engine. Use of such filters can severely damage your engine.

**Engine Air Cleaner Filter Selection**

The quality of replacement engine air cleaner filters varies considerably. Only high quality filters should be used to assure most efficient service. MOPAR engine air cleaner filters are a high quality filter and are recommended.

***Diesel Engine Air Cleaner Filter Inspection and Replacement***

Inspect engine air cleaner filter for dirt and or debris, if you find evidence of either dirt or debris you should change your air cleaner filter.

**Engine Air Cleaner Filter Removal**

1. Release the spring clips from the air cleaner cover.

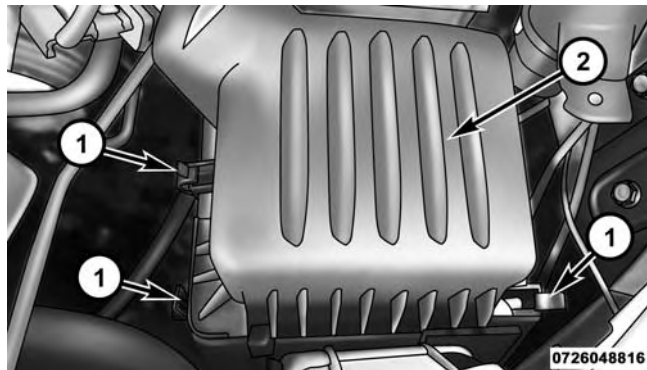

**Air Cleaner Filter Cover**

- 1 — Spring Clips
- 2 — Air Cleaner Filter Cover

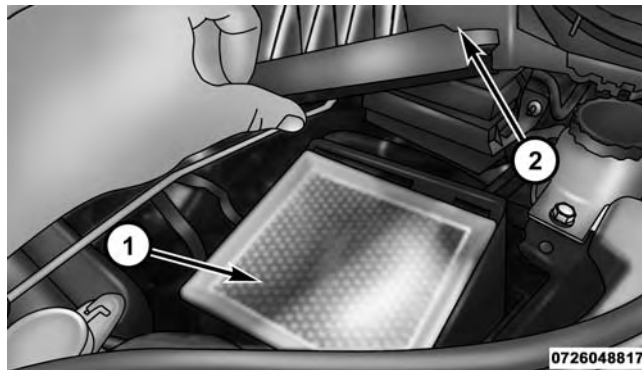

**Open Air Cleaner Filter Assembly**

- 1 — Air Cleaner Filter
- 2 — Air Cleaner Cover

2. Lift the air cleaner cover to access the air cleaner filter.
3. Remove the air cleaner filter element from the housing assembly.

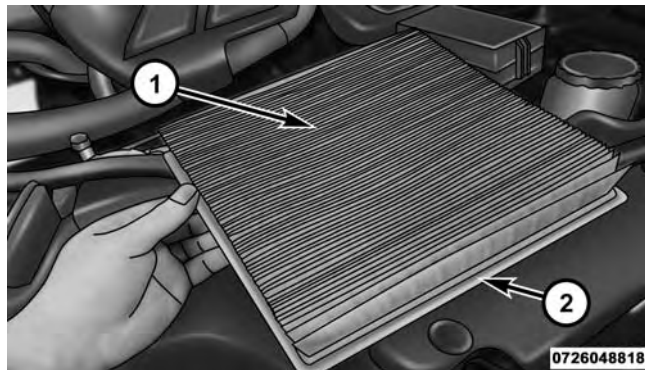

Air Cleaner Filter

- 1 — Air Cleaner Filter Inspection Surface  
 2 — Air Cleaner Filter

### Engine Air Cleaner Filter Installation

**NOTE:** Inspect and clean the housing if dirt or debris is present before replacing the air filter element.

1. Install the air cleaner filter element into the housing assembly with the air cleaner filter inspection surface facing downward.
2. Install the air cleaner cover onto the housing assembly locating tabs.
3. Latch the spring clips and lock the air cleaner cover to the housing assembly.

### Draining Fuel/Water Separator Filter

The fuel filter/water separator housing is located on the left side of the vehicle in front of the fuel tank. The best access to this water drain valve is from under the vehicle.

#### CAUTION!

- Do not drain the fuel/water separator filters when the engine is running.

*(Continued)*

**CAUTION!** *(Continued)*

- Diesel fuel will damage blacktop paving surfaces. Drain the filters into an appropriate container.

If water is detected in the water separator while the engine is running, or while the ignition switch is in the ON position, the “Water In Fuel Indicator Light” will illuminate and an audible chime will be heard. At this point you should stop the engine and drain the water from the filter housing.

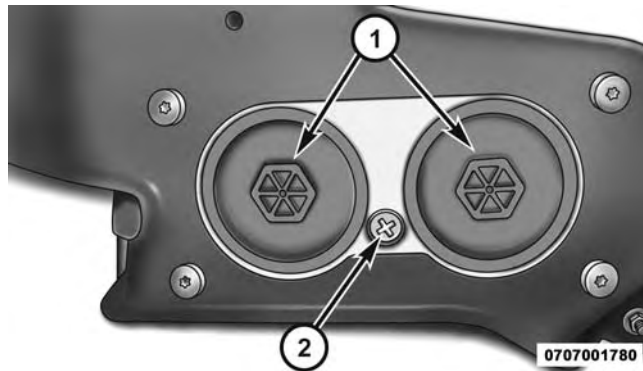
**Fuel Filter Assembly**

- 1 — Fuel Filter Access
- 2 — Water in Fuel Drain



**CAUTION!**

**If the “Water In Fuel Indicator Light” remains on, DO NOT START the engine before you drain water from the fuel filters to avoid engine damage.**

If the “Water In Fuel Indicator Light” comes on and a single chime are heard while you are driving, or with the ignition in the ON position, there may be a problem with your water separator wiring or sensor. See your authorized dealer for service.

Upon proper draining of the water from fuel filter assembly, the “Water In Fuel Indicator Light” will remain illuminated for approximately 10 seconds. If the water was drained while the engine was running, the “Water In Fuel Indicator Light” may remain on for approximately three minutes.

**NOTE:** Care should be taken in disposing of used fluids from your vehicle. Used fluids, indiscriminately discarded, can present a problem to the environment. Contact an authorized dealer, service station, or government agency for advice on recycling programs and for where used fluids and filters can be properly disposed of in your area.

Drain the fuel/Water separator filters when the “Water In Fuel Indicator Light” is ON. Within 10 minutes of vehicle shutdown, turn the filter drain valve (located on the bottom of the filter housing) counterclockwise to drain fuel/water; allow the accumulated water to drain. Leave the drain valve open until all water and contaminants have been removed. When clear fuel is visible, close the drain valve by turning it clockwise.

If more than two ounces or 60 milliliters of fuel have been drained, follow the directions for “Priming If The Engine Has Run Out Of Fuel.”

## Underbody Mounted Fuel Filter Replacement

**NOTE:** Using a fuel filter that does not meet the manufacturer's filtration and water separating requirements can severely impact fuel system life and reliability.

### CAUTION!

- Diesel fuel will damage blacktop paving surfaces. Drain the filter into an appropriate container.
- Do not prefill the fuel filter when installing a new fuel filter. There is a possibility debris could be introduced into the fuel filter during this action. It is best to install the filter dry and allow the in-tank lift pump to prime the fuel system.

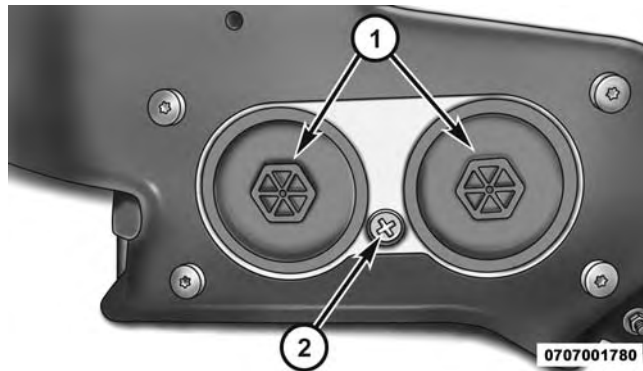

Fuel Filter Assembly

- 1 — Fuel Filter Access  
2 — Water in Fuel Drain

1. Ensure engine is turned off.
2. Place drain pan under the fuel filter assembly.

3. Open the water drain valve, and let any accumulated water drain.
4. Close the water drain valve.
5. Wipe clean the underside of the filter housing to prevent contamination from entering fuel system during service.
6. Remove using a socket. Rotate counterclockwise for removal.
7. Remove the used filter cartridge from the housing and dispose of according to your local regulations.
8. Wipe clean the sealing surfaces of the lid and housing.
9. Lubricate o-ring on new filter with clean engine oil.
10. Repeat steps 5 through 8 to service second filter in fuel filter assembly.

## Priming If The Engine Has Run Out Of Fuel

### WARNING!

**Do not open the high pressure fuel system with the engine running. Engine operation causes high fuel pressure. High pressure fuel spray can cause serious injury or death.**

1. Add a substantial amount of fuel to the tank, approximately 2 to 5 gal (8L to 19L).
2. Press ignition switch twice without your foot on brake to put vehicle in Run position. This will activate the in tank fuel pump for approximately 30 seconds. Repeat this process twice.
3. Start the engine using the "Normal Starting" procedure. Refer to "Starting Procedures" in "Starting and Operating" for further information.

**CAUTION!**

The starter motor will engage for approximately 30 seconds at a time. Allow two minutes between cranking intervals.

**NOTE:** The engine may run rough until the air is forced from all the fuel lines.

**WARNING!**

Do not use alcohol or gasoline as a fuel blending agent. They can be unstable under certain conditions and be hazardous or explosive when mixed with diesel fuel.

**CAUTION!**

Due to lack of lubricants in alcohol or gasoline, the use of these fuels can cause damage to the fuel system.

**NOTE:**

- Use of biodiesel mixture in excess of 20% can negatively impact the fuel filter's ability to separate water from the fuel, resulting in high pressure fuel system corrosion or damage.
- In addition, commercially available fuel additives are not necessary for the proper operation of your diesel engine.
- For extreme cold conditions, "Mopar Premium Diesel Fuel Treatment" is recommended to assist with cold starting.

## Intervention Regeneration Strategy — Message Process Flow

This engine meets all required diesel engine emissions standards. To achieve these emissions standards, your vehicle is equipped with a state-of-the-art engine and exhaust system. These systems are seamlessly integrated into your vehicle and managed by the Powertrain Control Module (PCM). The PCM manages engine combustion to allow the exhaust system's catalyst to trap and burn Particulate Matter (PM) pollutants, with no input or interaction on your part.

Additionally, your vehicle has the ability to alert you to additional maintenance required on your vehicle or engine.

Refer to "Driver Information Display (DID)" in "Understanding Your Instrument Panel" for further information.

### WARNING!

**A hot exhaust system can start a fire if you park over materials that can burn. Such materials might be grass or leaves coming into contact with your exhaust system. Do not park or operate your vehicle in areas where your exhaust system can contact anything that can burn.**

## Maintenance-Free Batteries

Your vehicle is equipped with a maintenance-free battery. The top of the maintenance-free battery is permanently sealed. You will never have to add water, nor is periodic maintenance required.

**CAUTION!**

It is essential when replacing the cables on the battery that the positive cable is attached to the positive post and the negative cable is attached to the negative post. Battery posts are marked (+) positive and negative (-) and are identified on the battery case. Also, if a "fast charger" is used while the battery is in vehicle, disconnect both vehicle battery cables before connecting the charger to the battery. Do not use a "fast charger" to provide starting voltage.

**WARNING!**

Battery posts, terminals, and related accessories contain lead and lead compounds. Always wash hands after handling the battery.

**Cooling System****WARNING!**

You or others can be badly burned by hot engine coolant (antifreeze) or steam from your radiator. If you see or hear steam coming from under the hood, do not open the hood until the radiator has had time to cool. Never try to open a cooling system pressure cap when the radiator is hot.

**Engine Coolant Checks**

Check the engine coolant (antifreeze) protection every 12 months (before the onset of freezing weather, where applicable). If the engine coolant (antifreeze) is dirty or rusty in appearance, the system should be drained, flushed and refilled with fresh coolant. Check the front of the A/C condenser (if equipped) or radiator for any accumulation of bugs, leaves, etc. If dirty, clean by gently

spraying water from a garden hose vertically down the face of the A/C condenser (if equipped) or the back of the radiator core.

Check the engine cooling system hoses for brittle rubber, cracking, tears, cuts and tightness of the connection at the coolant recovery bottle and radiator. Inspect the entire system for leaks.

With the engine at normal operating temperature (but not running), check the cooling system pressure cap for proper vacuum sealing by draining a small amount of engine coolant (antifreeze) from the radiator drain cock. The radiator drain cock is located in the lower radiator tank. If the cap is sealing properly, the engine coolant (antifreeze) will begin to drain from the coolant expansion bottle. **DO NOT REMOVE THE COOLANT PRESSURE CAP WHEN THE COOLING SYSTEM IS HOT.**

### **Cooling System — Drain Flush And Refill**

If the engine coolant (antifreeze) is dirty or contains a considerable amount of sediment, clean and flush with a reliable cooling system cleaner. Follow with a thorough rinsing to remove all deposits and chemicals. Properly dispose of old engine coolant (antifreeze).

Refer to the “Maintenance Schedule” for the proper maintenance intervals.

### **Selection Of Coolant**

Refer to “Fluids, Lubricants, And Genuine Parts” in “Maintaining Your Vehicle” for further information.

**CAUTION!**

- Mixing of engine coolant (antifreeze) other than specified Organic Additive Technology (OAT) engine coolant (antifreeze), may result in engine damage and may decrease corrosion protection. Organic Additive Technology (OAT) engine coolant is different and should not be mixed with Hybrid Organic Additive Technology (HOAT) engine coolant (antifreeze) or any “globally compatible” coolant (antifreeze). If a non-OAT engine coolant (antifreeze) is introduced into the cooling system in an emergency, the cooling system will need to be drained, flushed, and refilled with fresh OAT coolant (conforming to MS.90032), by an authorized dealer as soon as possible.
- Do not use water alone or alcohol-based engine coolant (antifreeze) products. Do not use additional

*(Continued)*

**CAUTION! (Continued)**

- rust inhibitors or antirust products, as they may not be compatible with the engine coolant and may plug the radiator.
- This vehicle has not been designed for use with propylene glycol-based engine coolant (antifreeze). Use of propylene glycol-based engine coolant (antifreeze) is not recommended.

**Adding Coolant**

Your vehicle has been built with an improved engine coolant (OAT coolant conforming to MS.90032) that allows extended maintenance intervals. This engine coolant (antifreeze) can be used up to ten years or 150,000 miles (240,000 km) before replacement. To prevent reducing this extended maintenance period, it is important that you use the same engine coolant (OAT coolant conforming to MS.90032) throughout the life of your vehicle.



Please review these recommendations for using Organic Additive Technology (OAT) engine coolant (antifreeze) that meets the requirements of FCA Material Standard MS.90032. When adding engine coolant (antifreeze):

- We recommend using MOPAR Antifreeze/Coolant 10 Year/150,000 Mile Formula OAT (Organic Additive Technology) that meets the requirements of FCA Material Standard MS.90032.
- Mix a minimum solution of 50% OAT engine coolant that meets the requirements of FCA Material Standard MS.90032 and distilled water. Use higher concentrations (not to exceed 70%) if temperatures below  $-34^{\circ}\text{F}$  ( $-37^{\circ}\text{C}$ ) are anticipated. Please contact your authorized dealer for assistance.
- Use only high purity water such as distilled or deionized water when mixing the water/engine coolant

(antifreeze) solution. The use of lower quality water will reduce the amount of corrosion protection in the engine cooling system.

**NOTE:**

- It is the owner's responsibility to maintain the proper level of protection against freezing according to the temperatures occurring in the area where the vehicle is operated.
- Some vehicles require special tools to add coolant properly. Failure to fill these systems properly could lead to severe internal engine damage. If any coolant is needed to be added to the system, please contact your local authorized dealer.
- Mixing engine coolant (antifreeze) types is not recommended and can result in cooling system damage. If HOAT and OAT coolant are mixed in an emergency,

have a authorized dealer drain, flush, and refill with OAT coolant (conforming to MS.90032) as soon as possible.

### Cooling System Pressure Cap

The cap must be fully tightened to prevent loss of engine coolant (antifreeze), and to ensure that the engine coolant (antifreeze) will return to the radiator from the coolant expansion bottle.

The cap should be inspected and cleaned if there is any accumulation of foreign material on the sealing surfaces.

#### **WARNING!**

- **Do not open hot engine cooling system. Never add engine coolant (antifreeze) when the engine is overheated. Do not loosen or remove the cap to cool an overheated engine. Heat causes pressure to**

*(Continued)*

#### **WARNING! (Continued)**

**build up in the cooling system. To prevent scalding or injury, do not remove the pressure cap while the system is hot or under pressure.**

- **Do not use a pressure cap other than the one specified for your vehicle. Personal injury or engine damage may result.**

### Disposal Of Used Engine Coolant

Used ethylene glycol-based engine coolant (antifreeze) is a regulated substance requiring proper disposal. Check with your local authorities to determine the disposal rules for your community. To prevent ingestion by animals or children, do not store ethylene glycol-based engine coolant (antifreeze) in open containers or allow it to remain in puddles on the ground. If ingested by a child or pet, seek emergency assistance immediately. Clean up any ground spills immediately.

## Points To Remember

**NOTE:** When the vehicle is stopped after a few miles/kilometers of operation, you may observe vapor coming from the front of the engine compartment. This is normally a result of moisture from rain, snow, or high humidity accumulating on the radiator and being vaporized when the thermostat opens, allowing hot engine coolant (antifreeze) to enter the radiator.

If an examination of your engine compartment shows no evidence of radiator or hose leaks, the vehicle may be safely driven. The vapor will soon dissipate.

- Do not overfill the coolant expansion bottle.
- Check the coolant freeze point in the radiator and in the coolant expansion bottle. If engine coolant (antifreeze) needs to be added, the contents of the coolant expansion bottle must also be protected against freezing.
- If frequent engine coolant (antifreeze) additions are required, the cooling system should be pressure tested for leaks.
- Maintain engine coolant (antifreeze) concentration at a minimum of 50% OAT coolant (conforming to MS.90032) and distilled water for proper corrosion protection of your engine which contains aluminum components.
- Make sure that the coolant expansion bottle overflow hoses are not kinked or obstructed.
- Keep the front of the radiator clean. If your vehicle is equipped with air conditioning, keep the front of the condenser clean.
- Do not change the thermostat for Summer or Winter operation. If replacement is ever necessary, install **ONLY** the correct type thermostat. Other designs may

result in unsatisfactory engine coolant (antifreeze) performance, poor gas mileage, and increased emissions.

### **Charge Air Cooler — Inter-Cooler**

The charge air cooler is positioned in front of the radiator and the air conditioner condenser. Air enters the engine through the air cleaner and passes through the turbocharger, where it is pressurized. This pressurized air rapidly reaches high temperature. The air is then directed through a hose to the charge air cooler and through another hose to the intake manifold of the engine. This cooling process enables more efficient burning of fuel resulting in fewer emissions.

To guarantee optimum performance of the system, keep the surfaces of the charge air cooler, condenser and radiator clean and free of debris. Periodically check the

hoses leading to and from the charge air cooler for cracks or loose clamps resulting in loss of pressure and reduced engine performance.

### **Brake System**

#### **Brake Master Cylinder — Brake Fluid Level Check**

The fluid level of the master cylinder should be checked when performing under the hood service, or immediately if the “Brake System Warning Light” indicates system failure.

The brake master cylinder has a translucent plastic reservoir. On the outboard side of the reservoir, there is a “MAX” mark and a “MIN” mark. The fluid level must be kept within these two marks. Do not add fluid above the full mark because leakage may occur at the cap.

With disc brakes, the fluid level can be expected to fall as the brake linings wear. However, an unexpected drop in fluid level may be caused by a leak and a system check should be conducted.

Refer to “Fluids, Lubricants, And Genuine Parts” in “Maintaining Your Vehicle” for further information.

**WARNING!**

- Use only manufacturer’s recommended brake fluid. Refer to “Fluids, Lubricants, and Genuine Parts” in “Maintaining Your Vehicle” for further information. Using the wrong type of brake fluid can severely damage your brake system and/or impair its performance. The proper type of brake fluid for your vehicle is also identified on the original factory installed hydraulic master cylinder reservoir.

*(Continued)*

**WARNING! (Continued)**

- To avoid contamination from foreign matter or moisture, use only new brake fluid or fluid that has been in a tightly closed container. Keep the master cylinder reservoir cap secured at all times. Brake fluid in an open container absorbs moisture from the air resulting in a lower boiling point. This may cause it to boil unexpectedly during hard or prolonged braking, resulting in sudden brake failure. This could result in an accident.
- Overfilling the brake fluid reservoir can result in spilling brake fluid on hot engine parts, causing the brake fluid to catch fire. Brake fluid can also damage painted and vinyl surfaces, care should be taken to avoid its contact with these surfaces.

*(Continued)*

**WARNING! (Continued)**

- Do not allow petroleum based fluid to contaminate the brake fluid. Brake seal components could be damaged, causing partial or complete brake failure. This could result in an accident.

**FLUID CAPACITIES**

	<b>U.S.</b>	<b>Metric</b>
<b>Fuel (Approximate)</b>		
3.0L Diesel Engine	24.6 Gallons	93.1 Liters
Diesel Exhaust Fluid Tank	8 Gallons	30.3 Liters
<b>Engine Oil With Filter</b>		
3.0 Liter Diesel Engine (SAE 5W-40 Synthetic, API CJ-4)	8 Quarts	7.7 Liters
<b>Cooling System</b>		
3.0L Turbo Diesel Engine (MOPAR Engine Coolant/Antifreeze 10 Year/150,000 Mile Formula OAT (Organic Additive Technology))	12 Quarts	11.4 Liters

## FLUIDS, LUBRICANTS AND GENUINE PARTS

### Engine

Component	Fluid, Lubricant, or Genuine Part
Engine Coolant	We recommend you use MOPAR Antifreeze/Coolant 10 Year/150,000 Mile Formula OAT (Organic Additive Technology).
Engine Oil	We recommend you use 5W-40 synthetic engine oil such as MOPAR or Shell Rotella that meets FCA Material Standard MS-10902 and the API CJ-4 or ACEA E9/E7 or ACEA A3/B4 engine oil category is required.
Engine Oil Filter	We recommend you use MOPAR Engine Oil Filters.
Fuel Filters	We recommend you use MOPAR Fuel Filter. Must meet 3 micron rating. <b>Using a fuel filter that does not meet the manufacturers filtration and water separating requirements can severely impact fuel system life and reliability.</b>
Fuel Selection	Use good quality diesel fuel from a reputable supplier in your vehicle. Federal law requires that you must fuel this vehicle with Ultra Low Sulfur Highway Diesel fuel (15 ppm Sulfur maximum) and prohibits the use of Low Sulfur Highway Diesel fuel (500 ppm Sulfur maximum) to avoid damage to the emissions control system. For

Component	Fluid, Lubricant, or Genuine Part
	most year-round service, No. 2 diesel fuel meeting ASTM specification D-975 Grade S15 will provide good performance. We recommend you use a blend of up to 5% biodiesel, meeting ASTM specification D-975 with your diesel engine. <b>This vehicle is compatible with biodiesel blends greater than 5% but no greater than 20% biodiesel meeting ASTM specification D-7467 provided the shortened maintenance intervals are followed as directed.</b>
Diesel Exhaust Fluid	MOPAR Diesel Exhaust Fluid (API Certified) (DEF) or equivalent that has been API Certified to the ISO 22241 standard. Use of fluids not API Certified to ISO 22241 may result in system damage.

**NOTE:** If the vehicle is exposed to extreme cold (below 20°F or -7°C), or is required to operate at colder-than-normal conditions for prolonged periods, use climatized No. 2 diesel fuel or dilute the No. 2 diesel fuel with 50% No. 1 diesel fuel. This will provide better protection from fuel gelling or wax-plugging of the fuel filters.



## Chassis

Component	Fluid, Lubricant, or Genuine Part
Automatic Transmission	Use only Mopar ZF 8&9 Speed ATF Automatic Transmission Fluid, or equivalent. Failure to use the correct fluid may affect the function or performance of your transmission.
Transfer Case – Single-Speed (Quadra-Trac I)	We recommend you use Shell Automatic Transmission Fluid 3353.
Transfer Case – Two-Speed (Quadra-Trac II)	We recommend you use MOPAR ATF+4 Automatic Transmission Fluid.
Axle Differential (Front)	We recommend you use MOPAR GL-5 Synthetic Axle Lubricant SAE 75W-85.
Axle Differential (Rear) – With Electronic Limited-Slip Differential (ELSD)	We recommend you use MOPAR GL-5 Synthetic Axle Lubricant SAE 75W-85 with friction modifier additive.
Axle Differential (Rear) – Without Electronic Limited-Slip Differential (ELSD)	We recommend you use MOPAR GL-5 Synthetic Axle Lubricant SAE 75W-85.

Component	Fluid, Lubricant, or Genuine Part
Brake Master Cylinder	We recommend you use MOPAR DOT 3 Brake Fluid, SAE J1703 should be used. If DOT 3, SAE J1703 brake fluid is not available, then DOT 4 is acceptable.

# MAINTENANCE SCHEDULE

## CONTENTS

---

■ MAINTENANCE SCHEDULE . . . . .	.98	□ Additional Maintenance — B6 To B20	
□ Maintenance Chart — Diesel Fuel Up To B5		Biodiesel. . . . .	.102
Biodiesel. . . . .	.100		

## MAINTENANCE SCHEDULE

Your vehicle is equipped with an automatic oil change indicator system. The oil change indicator system will remind you that it is time to take your vehicle in for scheduled maintenance.

Based on engine operation conditions, the oil change indicator message will illuminate. This means that service is required for your vehicle. Operating conditions such as frequent short-trips, trailer tow, extremely hot or cold ambient temperatures will influence when the “Oil Change Required” message is displayed. Severe Operating Conditions can cause the change oil message to illuminate as early as 3,500 miles (5,600 km) since last reset. Have your vehicle serviced as soon as possible, within the next 500 miles (805 km).

Your authorized dealer will reset the oil change indicator message after completing the scheduled oil change. If a scheduled oil change is performed by someone other

than your authorized dealer, the message can be reset by referring to the steps described under “Driver Information Display (DID)” in “Understanding Your Instrument Panel” for further information.

**NOTE:** Under no circumstances should oil change intervals exceed 10,000 miles (16,000 km) or twelve months, whichever comes first.

### Engine Oil Filter Replacement

Residual oil in the housing may spill from the housing when the new filter is installed if the residual oil is not either removed from the housing or enough time has not elapsed to allow the oil to drain back into the engine. When servicing the oil filter on this engine, carefully remove the filter and use a suction gun to remove any residual oil left in the housing or wait about 30 minutes for the oil to drain back into the engine.

**Once A Month Or Before A Long Trip:**

- Check engine oil level
- Check windshield washer fluid level
- Check the tire inflation pressures and look for unusual wear or damage
- Check the fluid levels of the coolant reservoir, brake master cylinder, and fill as needed
- Check function of all interior and exterior lights

**Required Maintenance**

Refer to the Maintenance Schedules on the following pages for required maintenance.

<b>At Every Oil Change Interval As Indicated By Oil Change Indicator System:</b>
<ul style="list-style-type: none"> <li>• Change oil and filter.</li> </ul>
<ul style="list-style-type: none"> <li>• Completely fill the Diesel Exhaust Fluid tank.</li> </ul>

<b>At Every Oil Change Interval As Indicated By Oil Change Indicator System:</b>
<ul style="list-style-type: none"> <li>• Drain water from fuel filter assembly.</li> </ul>
<ul style="list-style-type: none"> <li>• Rotate the tires. <b>Rotate at the first sign of irregular wear, even if it occurs before the oil indicator system turns on.</b></li> </ul>
<ul style="list-style-type: none"> <li>• Inspect battery and clean and tighten terminals as required.</li> </ul>
<ul style="list-style-type: none"> <li>• Inspect brake pads, shoes, rotors, drums, hoses and park brake.</li> </ul>
<ul style="list-style-type: none"> <li>• Inspect engine cooling system protection and hoses.</li> </ul>
<ul style="list-style-type: none"> <li>• Inspect exhaust system.</li> </ul>
<ul style="list-style-type: none"> <li>• Inspect engine air cleaner if using in dusty or off-road conditions.</li> </ul>

## Maintenance Chart — Diesel Fuel Up To B5 Biodiesel

Mileage or time passed (whichever comes first)	10,000	20,000	30,000	40,000	50,000	60,000	70,000	80,000	90,000	100,000	110,000	120,000	130,000	140,000	150,000
Or Years:	1	2	3	4	5	6	7	8	9	10	11	12	13	14	15
Or Kilometers:	16,000	32,000	48,000	64,000	80,000	96,000	112,000	128,000	144,000	160,000	176,000	192,000	208,000	224,000	240,000
<b>Additional Inspections</b>															
Completely fill the Diesel Exhaust Fluid tank.	X	X	X	X	X	X	X	X	X	X	X	X	X	X	X
Inspect the CV joints.			X			X			X			X			X
Inspect front suspension, tie rod ends, and replace if necessary.		X		X		X		X		X		X		X	
Inspect the front and rear axle fluid, change if using your vehicle for police, taxi, fleet, off-road or frequent trailer towing.		X		X		X		X		X		X		X	
Inspect the brake linings, parking brake function.		X		X		X		X		X		X		X	
Inspect transfer case fluid.			X			X			X						X

Mileage or time passed (whichever comes first)	10,000	20,000	30,000	40,000	50,000	60,000	70,000	80,000	90,000	100,000	110,000	120,000	130,000	140,000	150,000
	Or Years:	1	2	3	4	5	6	7	8	9	10	11	12	13	14
Or Kilometers:	16,000	32,000	48,000	64,000	80,000	96,000	112,000	128,000	144,000	160,000	176,000	192,000	208,000	224,000	240,000
<b>Additional Maintenance</b>															
Drain water from fuel filter assembly.	X	X		X	X		X	X		X	X		X	X	
Replace fuel filters and drain water from the fuel filter assembly.			X			X			X			X			X
Replace engine air filter.			X			X			X			X			X
Replace the air conditioning filter.		X		X		X		X		X		X		X	
Flush and replace the engine coolant at 10 years or 150,000 miles (240,000 km) whichever comes first.										X					X
Replace accessory drive belt(s).										X					
Change transfer case fluid.												X			

**WARNING!**

- You can be badly injured working on or around a motor vehicle. Do only service work for which you have the knowledge and the right equipment. If you have any doubt about your ability to perform a service job, take your vehicle to a competent mechanic.
- Failure to properly inspect and maintain your vehicle could result in a component malfunction and effect vehicle handling and performance. This could cause an accident.

**Additional Maintenance — B6 To B20 Biodiesel****NOTE:**

- Under no circumstances should oil change intervals exceed 8,000 miles (12 875 km) or six months, whichever comes first when using Biodiesel blends greater than 5% (B5).
- The owner is required to monitor mileage for B6-B20 biodiesel, the automatic oil change indicator system does not reflect the use of biofuels.



Additional Maintenance Chart — B6 to B20 Biodiesel

Mileage or time passed (whichever comes first)	10,000	20,000	30,000	40,000	50,000	60,000	70,000	80,000	90,000	100,000	110,000	120,000	130,000	140,000	150,000
Or Years:	1	2	3	4	5	6	7	8	9	10	11	12	13	14	15
Or Kilometers:	16,000	32,000	48,000	64,000	80,000	96,000	112,000	128,000	144,000	160,000	176,000	192,000	208,000	224,000	240,000
<b>Additional B6 to B20 Maintenance</b>															
Replace fuel filters and drain water from the fuel filter assembly.		X		X		X		X		X		X		X	

**WARNING!**

- You can be badly injured working on or around a motor vehicle. Do only service work for which you have the knowledge and the right equipment. If you have any doubt about your ability to perform a service job, take your vehicle to a competent mechanic.
- Failure to properly inspect and maintain your vehicle could result in a component malfunction and effect vehicle handling and performance. This could cause an accident.

# INDEX

Adding Engine Coolant (Antifreeze) . . . . .	.86	Caps, Filler	
Adding Fuel . . . . .	.60	Oil (Engine) . . . . .	.73
Air Cleaner, Engine (Engine Air Cleaner Filter) . . . . .	.74	Radiator (Coolant Pressure) . . . . .	.88
Air Conditioning Filter . . . . .	.75	Charge Air Cooler . . . . .	.90
Antifreeze (Engine Coolant) . . . . .	.85	Coolant Pressure Cap (Radiator Cap) . . . . .	.88
Capacities . . . . .	.92	Cooling System . . . . .	.84
Disposal . . . . .	.88	Adding Coolant (Antifreeze) . . . . .	.86
Automatic Transmission		Coolant Capacity . . . . .	.92
Fluid Type . . . . .	.95	Coolant Level . . . . .	.84
Axle Fluid . . . . .	.95	Disposal Of Used Coolant . . . . .	.88
		Drain, Flush, And Refill . . . . .	.85
Battery . . . . .	.83	Points To Remember . . . . .	.89
Brake Fluid . . . . .	.95	Pressure Cap . . . . .	.88
Brake System . . . . .	.90	Radiator Cap . . . . .	.88
Fluid Check . . . . .	.90	Selection Of Coolant (Antifreeze) . . . . .	.85, 93
Master Cylinder . . . . .	.90		
Capacities, Antifreeze (Engine Coolant) . . . . .	.92	Diesel Fuel . . . . .	.41
Capacities, Fluid . . . . .	.92	Diesel Fuel Requirements . . . . .	.41
		Bulk Storage Of . . . . .	.63

Diesel Fuel System, Re-Priming . . . . .	.81	Oil Filler Cap . . . . .	.73
Disposal		Filters	
Antifreeze (Engine Coolant) . . . . .	.88	Air Cleaner . . . . .	.74
Draining Fuel/Water Separator Filter . . . . .	.77	Air Conditioning . . . . .	.75
Driver Information Display		Engine Fuel . . . . .	.77
DID . . . . .	.18, 21	Engine Oil . . . . .	.74, 93
Instrument Cluster . . . . .	.18	Engine Oil Disposal . . . . .	.74
Instrument Cluster Display . . . . .	.18, 21	Fluid, Brake . . . . .	.95
Engine . . . . .	.70	Fluid Capacities . . . . .	.92
Air Cleaner . . . . .	.74	Fluid Level Checks	
Block Heater . . . . .	.32, 40	Brake . . . . .	.90
Break-In Recommendations . . . . .	.9	Fluids, Lubricants And Genuine Parts . . . . .	.93
Compartment . . . . .	.70	Fuel . . . . .	.41
Coolant (Antifreeze) . . . . .	.93	Adding . . . . .	.60
Identification . . . . .	.70	Diesel . . . . .	.41, 93
Idling . . . . .	.38	Filter . . . . .	.77
Oil . . . . .	.71, 93	Requirements . . . . .	.41

Specifications . . . . .	.42	Manual Transmission	
Tank Capacity . . . . .	.92	Lubricant Selection . . . . .	.95
Fueling . . . . .	.60		
		New Vehicle Break-In Period . . . . .	.9
Gauges			
Voltmeter . . . . .	.35	Oil, Engine. . . . .	.21, 71, 93
Gross Axle Weight Rating . . . . .	.47	Capacity . . . . .	.92
Gross Vehicle Weight Rating . . . . .	.46	Change Interval . . . . .	.73
		Dipstick . . . . .	.72
Hitches		Disposal . . . . .	.74
Trailer Towing . . . . .	.49	Filter . . . . .	.74, 93
		Filter Disposal . . . . .	.74
Instrument Cluster . . . . .	.12	Materials Added To . . . . .	.74
Intervention Regeneration Strategy . . . . .	.23, 83	Recommendation . . . . .	.71
		Viscosity . . . . .	.73
Maintenance Procedures . . . . .	.71		
Maintenance Schedule. . . . .	.98	Power Steering Fluid . . . . .	.95

Radiator Cap (Coolant Pressure Cap) . . . . .	.85, 88	Trailer Towing . . . . .	.46
Remote Starting System . . . . .	.8	Cooling System Tips . . . . .	.58
Schedule, Maintenance . . . . .	.98	Hitches . . . . .	.49
Selection Of Coolant (Antifreeze) . . . . .	.93	Minimum Requirements . . . . .	.52
Starting . . . . .	.31	Trailer And Tongue Weight . . . . .	.51
Automatic Transmission . . . . .	.32	Wiring . . . . .	.56
Engine Block Heater . . . . .	.32, 40	Trailer Towing Guide . . . . .	.51
Remote . . . . .	.8	Trailer Weight . . . . .	.51
Starting Procedures . . . . .	.31	Transfer Case	
Starting Procedures (Diesel Engines) . . . . .	.31	Fluid . . . . .	.95
Tires		Transmission	
Trailer Towing . . . . .	.54	Fluid . . . . .	.95
Tongue Weight/Trailer Weight . . . . .	.51	Viscosity, Engine Oil . . . . .	.73
Towing . . . . .	.46	Voltmeter . . . . .	.35
Guide . . . . .	.51	Water Separator, Diesel Fuel . . . . .	.77
Weight . . . . .	.51		

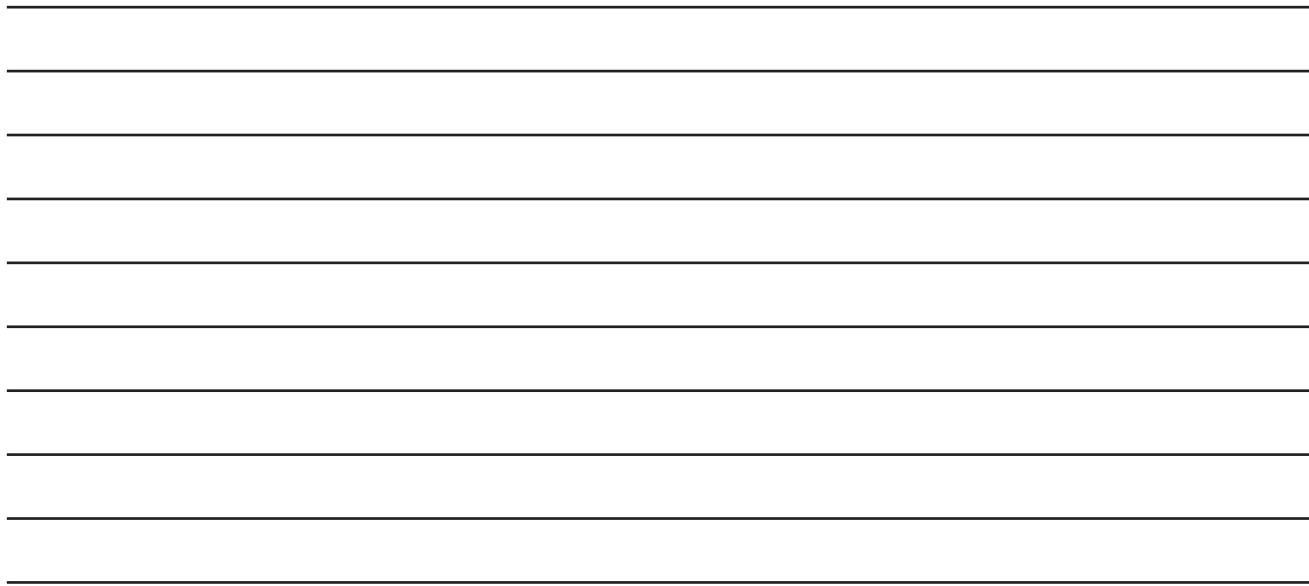



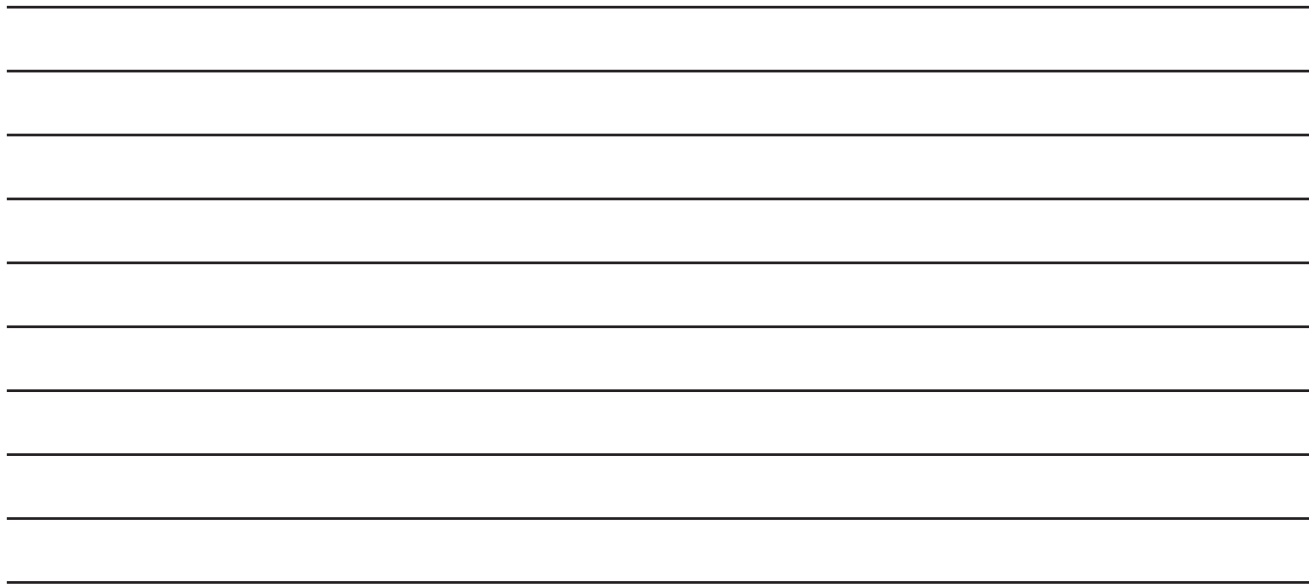

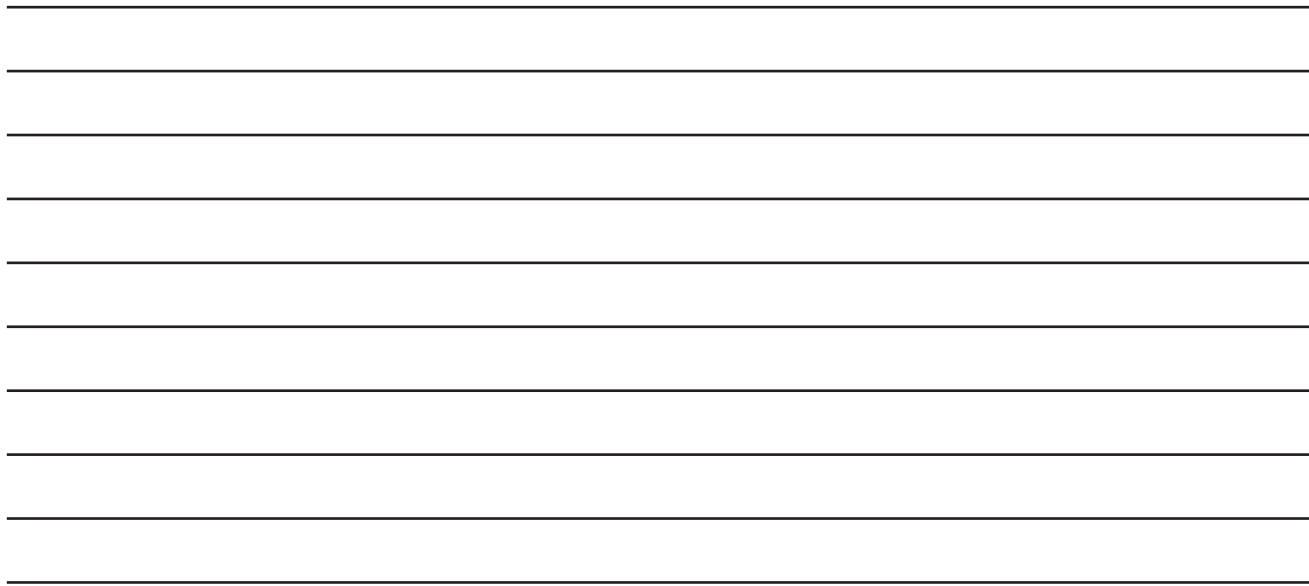

## **INSTALLATION OF RADIO TRANSMITTING EQUIPMENT**

Special design considerations are incorporated into this vehicle's electronic system to provide immunity to radio frequency signals. Mobile two-way radios and telephone equipment must be installed properly by trained personnel. The following must be observed during installation.

The positive power connection should be made directly to the battery and fused as close to the battery as possible. The negative power connection should be made to body sheet metal adjacent to the negative battery connection. This connection should not be fused.

Antennas for two-way radios should be mounted on the roof or the rear area of the vehicle. Care should be used in mounting antennas with magnet bases. Magnets may affect the accuracy or operation of the compass on vehicles so equipped.

The antenna cable should be as short as practical and routed away from the vehicle wiring when possible. Use only fully shielded coaxial cable.

Carefully match the antenna and cable to the radio to ensure a low Standing Wave Ratio (SWR).

Mobile radio equipment with output power greater than normal may require special precautions.

All installations should be checked for possible interference between the communications equipment and the vehicle's electronic systems.

# Jeep®

**STICK WITH THE SPECIALISTS®**

16WK741-226-AA

©2016 FCA US LLC. All Rights Reserved.

Jeep is a registered trademark of FCA US LLC.



Third Edition  
Printed in U.S.A.